

OCTOBER 1977  
\$1.00

THE SOUND ENGINEERING MAGAZINE

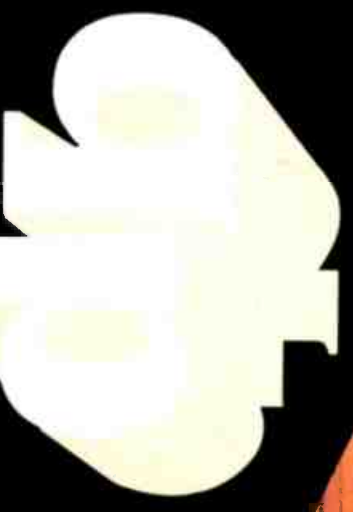

AKUQWA325COM11 10 DB JAN79  
KUOW RADIO  
D S 50 UNIV OF WASH  
325 COMMUNICATIONS BLDG  
CEATTI F WA 98105

*It's not for you.  
It's for them.*



Why do you think it's called public address?

The audience is there to have a good time. You're there to work. But, if you're not projecting the sound you've worked so hard to perfect, you just wasted all those long hours in rehearsal.

Now that you're increasing your public, it's time to address yourself to an investment in PA. Check out Yamaha's EM-Series of affordable, fully-integrated sound reinforcement systems.

The EM-80, 100 and 150 integrated mixer/amplifiers. From four to six input channels, from 60- to 150-watts RMS. Link them together for even greater flexibility. They're reliable and roadable because they're built Yamaha tough.

Yamaha's unique stereo balance control lets you optimize sound levels in different parts of a room. Practically any setup is possible with combinations of microphones and electric instruments taken direct, amplified and submixed.

When it comes to speakers, Yamaha has two impressive models to choose from.

Every component is made by Yamaha to our own exacting specifications. Yamaha's super-efficient, two-way S4115H enclosures with a horn-loaded 15" woofer, HF horn/driver combination with level control, and 100 watts power handling, make perfect mains. On the other hand, our S0112T enclosure with 10" and 12" woofers, four 2" cone-type tweeters, and 80 watts power handling, are ideal as stage monitors or excellent low-cost house mains. Both models have built-in passive crossovers, and are available with built-in power amps.

For all the facts, send this ad along with four dollars. (Please, certified check or money order only. No cash or personal checks.) We'll rush you an operation manual complete with block diagrams on our EM-Series. Or better yet, see your Yamaha dealer and plug-in to an EM. It may be for your audiences, but their enjoyment is going to pay off for you.



Musical Instrument/Combo Division  
6600 Orangethorpe Avenue, Buena Park, CA 90620  
Write: P.O. Box 6600, Buena Park, CA 90622

Circle 10 on Reader Service Card

[www.americanradiohistory.com](http://www.americanradiohistory.com)

## Coming Next Month

• November is the tenth anniversary of db's publication. Accordingly, we went back to look at where we started, and will again publish articles that detail the state of the audio art. Not the state of ten years ago, but new articles on the state of today's art. Among the writers will be **Norman H. Crowhurst, Irv Diehl, and John M. Woram**. One of the features will be a picture and text gallery of recent products that have advanced the audio state of the art.

## About The Cover



• Cover squibs got confused last month. The description then, repeated again, is for this cover. Last month, we had as a cover the \$250 Diamond Disc Phonograph. The disc continued Edison's use of vertical groove cutting.

This cover shows a 1906 Edison Home Phonograph Model-C. As a cylindrical type with a sophisticated (for its time) spring motor, speed constancy was achieved. And since there was straight line tracking of the stylus, sound was equal in quality from the start to the finish. If you think that modern stylus shapes are a recent development, note that this system had an elliptically polished stylus. As with all Edison units, even later discs, groove modulation was vertical (hill and dale). We thank the Audio Technica Company both in the U.S. and Japan for the photograph by Susumo Endo.

# db

THE SOUND ENGINEERING MAGAZINE

OCTOBER 1977 VOLUME 11, NUMBER 10

40	DOLBY B PROCESSING FOR F.M. AND T.V. David Robinson
44	A VARIABLE SPEECH CONTROL Martin Dickstein
48	THE STEREO VECTORSCOPE Sidney S. Smith
2	LETTERS
6	CALENDAR
10	BROADCAST SOUND Patrick S. Finnegan
18	THEORY AND PRACTICE Norman H. Crowhurst
26	THE SYNC TRACK John M. Woram
32	SOUND WITH IMAGES Martin Dickstein
36	NEW PRODUCTS AND SERVICES
53	CLASSIFIED
56	PEOPLE, PLACES, HAPPENINGS

db is listed in **Current Contents: Engineering and Technology**

<b>Larry Zide</b> EDITOR-PUBLISHER	<b>John M. Woram</b> ASSOCIATE EDITOR
<b>Bob Laurie</b> ART DIRECTOR	<b>Hazel Krantz</b> COPY EDITOR
<b>Eloise Beach</b> CIRCULATION MANAGER	<b>Lydia Anderson</b> BOOK SALES
<b>Ann Russell</b> ADVERTISING PRODUCTION	<b>Crescent Art Service</b> GRAPHICS AND LAYOUT

db, the Sound Engineering Magazine is published monthly by Sagamore Publishing Company, Inc. Entire contents copyright © 1977 by Sagamore Publishing Co., Inc., 1120 Old Country Road, Plainview, L.I., N.Y. 11803. Telephone (516) 433 6530. db is published for those individuals and firms in professional audio-recording, broadcast, audio-visual, sound reinforcement, consultants, video recording, film sound, etc. Application should be made on the subscription form in the rear of each issue. Subscriptions are \$7.00 per year (\$14.00 per year outside U.S. Possessions, Canada and Mexico) in U.S. funds. Single copies are \$1.00 each. Controlled circulation paid at Brattleboro, VT 05301. Editorial, Publishing, and Sales Offices: 1120 Old Country Road, Plainview, New York 11803. Postmaster: Form 3579 should be sent to above address.

# Now... 3009 Series III



Write to Dept 1846, SME Limited  
Steving, Sussex, BN4 3GY, England

*Exclusive distributors for the U.S.:*  
Shure Brothers Incorporated  
222 Hartrey Avenue  
Evanston, Illinois 60204

*and in Canada:*

A. C. Simmonds and Sons Ltd  
975 Dillingham Road  
Pickering, Ontario, L1W 3B2

# SME

# db Letters

## THE EDITOR:

As a designer of f.m. audio processing equipment, I would like to comment on the letters from Messrs. Purcell and Gibb in the July issue of *db*.

The a.m. and f.m. broadcast media are, in 1977, both unquestionably *mass* media. The FCC requires the broadcaster to serve the "public interest, convenience, and necessity." Thus the audio purist cannot be favored at the expense of the larger radio audience, unless said majority happens to be audio purists. This puts both the designers and users of signal processing equipment in a philosophical bind—how to best serve the *entire* audience of the radio station.

Most of the signal processing by-products mentioned by Mr. Purcell are a result of unsophisticated design and/or unit-to-unit incompatibility of much existing signal processing equipment. "Pumping," noise swish-up, and audible distortion are totally unnecessary and have nothing to do with the basic process of compressing the dynamic range of the broadcast signal. In fact, if transmitter and receiver are reasonably well designed, if the station console, turntables and tape recorders are well maintained, and if a systems approach is taken (as in the Orban Optimod-FM) the principal source of audible distortion in f.m. reception is multipath. Unfortunately, most of the audience cannot, for practical reasons, employ the highly directional outdoor antenna system with rotor necessary to minimize the effects of the multipath.

In addition, much of the audience does considerable listening in automobiles. In the case of mobile reception, the average modulation of the f.m. carrier becomes highly important, both to minimize the effects of "picket-fencing" and to help the receiver capture and hold the signal in locations where two f.m. stations on the same frequency both transmit signals of substantial strength.

There is evidence that the audience *prefers* a somewhat compressed signal. Both concert music stations in our area employ moderate compression, and the Chief Engineer of one reports that when the dynamic range of the transmission is permitted to exceed 30 dB, the listener complaints proliferate! Evidently, most of the audience does not sit all day in front of their loudspeakers listening intently, but rather use the station as a

## index of advertisers

Acoustilog . . . . .	20
AES . . . . .	30
Audio Distributors . . . . .	34
Ball Corporation . . . . .	5
B&K Instruments . . . . .	41
Cetec Audio . . . . .	25
Community Light & Sound . . . . .	23
Crown International . . . . .	12
dbx . . . . .	8
Duncan Electronics . . . . .	11
Garner Industries . . . . .	47
Harris Corporation . . . . .	22
Inovonics . . . . .	33
Ivie Electronics . . . . .	9
J&R Music World . . . . .	33
Leader Instruments . . . . .	24
Lexicon . . . . .	4
Orban/Parasound . . . . .	49
Permag . . . . .	47
Recording Supply Co. . . . .	32
SAE . . . . .	10
Saki Magnetics . . . . .	26
Shure Brothers . . . . .	21
Eric Small & Associates . . . . .	38
SME Limited . . . . .	2
Standard Tape Labs . . . . .	16
Stanton Magnetics . . . . .	7
Studer Revox . . . . .	3
Tangent Systems . . . . .	18
Tapco . . . . .	31
Tara Audio Sales Ltd. . . . .	34
TDX . . . . .	37
TEAC Corp. of America . . . . .	Cover 4
Technics by Panasonic . . . . .	13, 15, 17, 19
Tentel . . . . .	41
The London Company . . . . .	35
3-M . . . . .	28-29
Uni-Sync . . . . .	27
UREI . . . . .	6
VIP International . . . . .	32
Waters Mfg. . . . .	14
White Instruments . . . . .	22
Yamaha . . . . .	Cover 2

## db sales offices

### THE SOUND ENGINEERING MAGAZINE

#### New York

1120 Old Country Rd.  
Plainview, N.Y. 11803 516-433-6530

#### Roy McDonald Associates, Inc. Dallas

Stemmons Tower West, Suite 714  
Dallas, Texas 75207 214-637-2444

#### Denver

3540 South Poplar St.  
Denver, Colo. 80237 303-758-3325

#### Houston

3130 Southwest Freeway  
Houston, Tex. 77006 713-529-6711

#### Los Angeles

500 S. Virgil, Suite 360  
Los Angeles, Cal. 90020 213-381-6106

#### Portland

2035 S. W. 58th Ave.  
Portland, Ore. 97221 503-292-8521

#### San Francisco

Suite 265, 5801 Christle Ave.  
Emeryville, Cal. 94608 415-653-2122

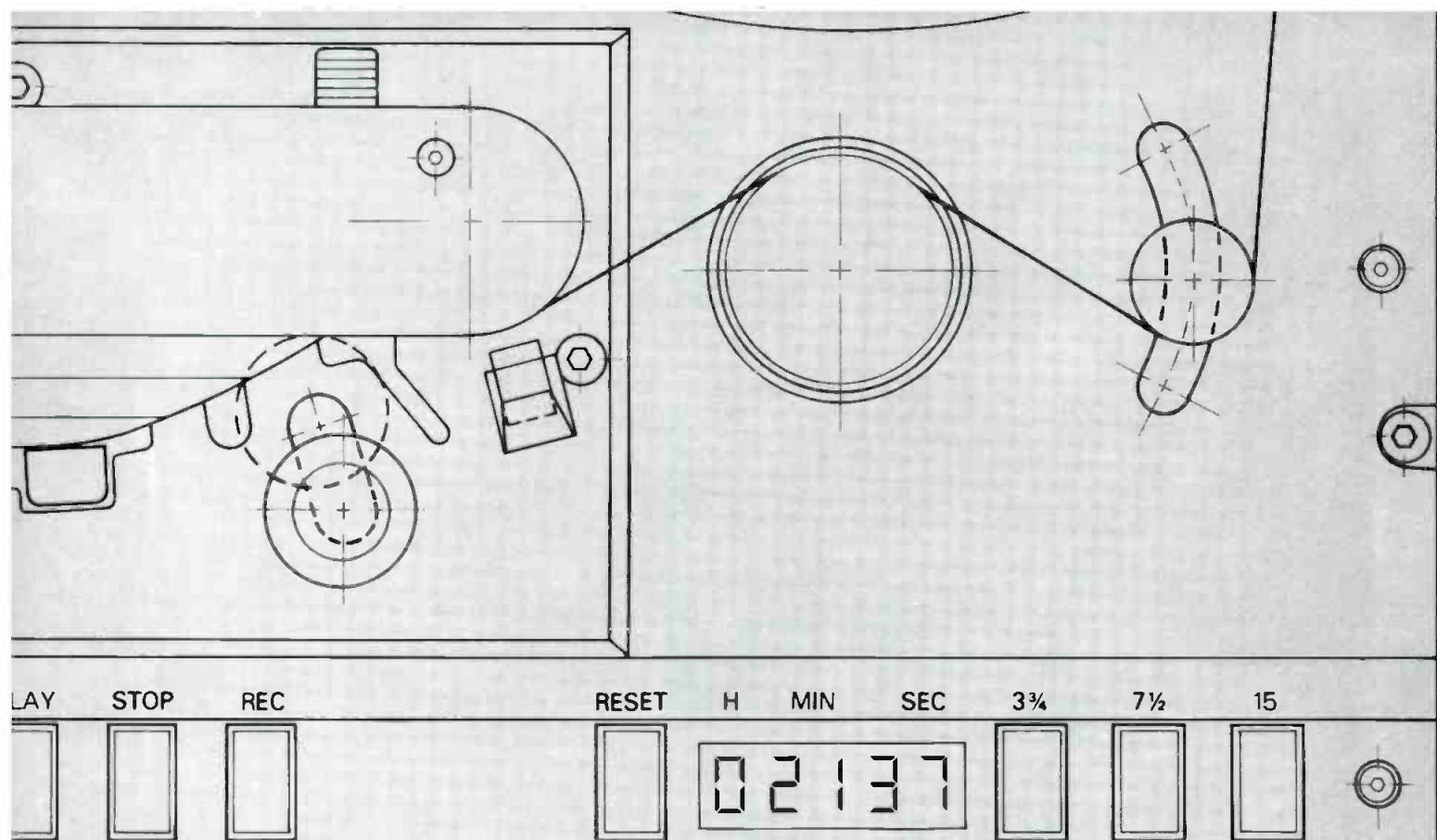

# Studer B67

**It's got competitors...  
but no competition!**

**STUDER**

B 67 TAPE RECORDER



When you buy the Studer B67 tape recorder/reproducer, you get more than just one of the world's finest tape recorders.

You are buying an engineering philosophy where performance is first and there isn't any second or third. You are buying a dedication to quality seldom seen in today's world of "make 'em faster and cheaper." At Studer, one person in every seven is a quality assurance inspector.

You are buying performance that stays within spec long after lesser equipment has given up. If performance is an important part of your tape recorder buying decision, test drive the Studer B67 before you decide. You'll find the B67 is the recorder without competition.

To learn more, circle reader service number or contact:

**STUDER REVOX**

October 1977 db

If you're after a bigger share of the recording business, we've just made things a lot easier for you.

Our new lower price tag significantly lowers the cost of our Delta-T 102 Series Digital Delays putting them in reach of those studios, that up till now, have found this equipment beyond their budgets.

You get a lot for your money. Our 102-S is the cleanest-sounding unit made. The most versatile. The most exciting to work with. You get two independent delay lines in a single chassis. Couple them with our new VCO module and you get special effects like you never had before: vibrato, doubling with time delay and pitch shift, time delay panning, doppler shift, and a whole lot more.

You can start with the basics, if you wish, and build as you go—thanks to Delta-T's cost-saving modular design. Our 102-S bulletin has the whole story. We'll send you our new prices, application brochure, and a demo record. A note on your letterhead brings you all four. Write today.

**Lexicon**

60 Turner Street, Waltham,  
Massachusetts 02154  
(617) 891-6790



Export agent: Gotham Export Corporation, 741 Washington Street, New York, New York 10014

Circle 35 on Reader Service Card

www.americanradiohistory.com

letters (cont.)

pleasant background for other activities over relatively long periods of time. These people do not want to have music blast at them or become so faint that they can't hear it at moderate volume settings. They might listen to far louder phonograph records; in this latter case, they have chosen the music themselves and the situation is active rather than passive. Clearly, the esthetics of compression are far more subtle than the "noble purist vs. crass money-grubber" view might suggest.

On to the technical specifics: It is our opinion that the 75 uS preemphasis can be dealt with by subtle high frequency limiting so successfully that the audience would never be aware that such limiting was taking place unless presented with a direct a/b comparison with the original source. In such a comparison, no differences in brightness will be noticed (for a vast majority of the time). Brass can lose a certain bite; cymbals can lose some impact. However, bizarre audible side effects associated with certain broadcast h-f limiters (particularly of older design) are indicative of poor design rather than inevitable side effects of the h-f limiting process.

We have publicly demonstrated our Optimod-FM limiter/compressor/stereo generator system many times at trade shows. In all cases, direct a/b with the original 15 in/sec. source tape was available. In most cases, broadcasters auditing the system (for a vast majority of program material) could discern *no* difference in brightness or distortion through high-quality electrostatic headphones.

An option is available for the Optimod-FM which allows it to accept the Dolby f.m. broadcast encoder. As we have publicly demonstrated at NAB in 1977, the Dolby process makes a clear, but somewhat subtle, improvement when decoded properly. Transmission noise reduction is quite effective and worthwhile. However, when phonograph records are used as the source material, only the most marginal improvement in high frequency power response is discerned, when compared to the Optimod-processed signal. If 15 in/sec. tape or other medium with superior high frequency power capability is employed, more substantial improvement would be expected.

When the Dolby-processed signal is decoded through a conventional 75 uS receiver, substantial high level, high frequency loss is perceived compared to the original source or the Optimod-FM processed signal. In

# There's a whole new business in the accessory department.

In the short time it's been around, Sound Guard<sup>®</sup> record preservative is setting records in just about every outlet it's in.

Because it works.

For your customers, Sound Guard maintains sound fidelity by reducing record wear and resisting dust accumulation with its built-in, permanent anti-static property.

For you, it's something more than a major breakthrough in record care. Sound Guard is a remarkable product that's creating more sales where today's smart money is—your accessory department.

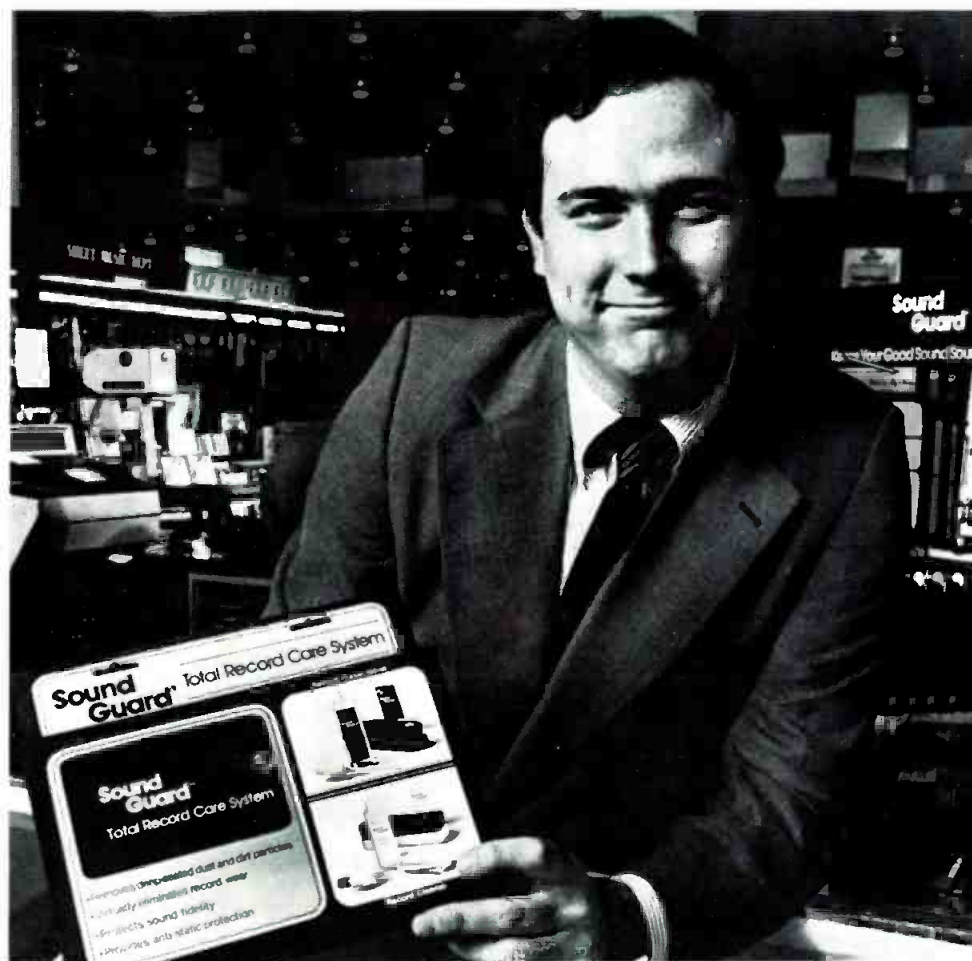

## And now, two new Sound Guard products:

1. Sound Guard<sup>™</sup> record cleaner kit.

Developed for both light and thorough cleaning to remove everything from dust particles to oily fingerprints.

2. Sound Guard<sup>™</sup> Total Record Care System.

Sound Guard record preservative and Sound Guard record cleaner—all in one package. There's no other system like it for total record care.

See your Sound Guard representative.



## Sound Guard<sup>®</sup> keeps your good sounds sounding good.



Sound Guard preservative—Sound Guard cleaner—Sound Guard Total Record Care System  
Sound Guard is Ball Corporation's registered trademark. Copyright © Ball Corporation, 1977. Muncie, IN 47302

# Now Two Smart Plotter Plug-ins for Our Top Draw-er

## MODEL 2010 LEVEL AND FREQUENCY DETECTOR

The new UREI Model 2010 is the second of a series of plug-in modules for our Model 200 X-Y Plotter. The 2010 module enables the 200 to plot both amplitude and frequency information received from coherent signals such as pre-recorded test tapes, records or other remote signal sources. It features SFD (Smart Frequency Detection) which distinguishes between coherent signals and random voice-type interruptions. The circuit stores the last measured frequency in memory, lifts the pen, and waits for new updated frequency and level information before continuing. It can be synchronized from either the input signal or a different external source for plotting channel separation, head crosstalk, etc.

## MODEL 2000 AUTOMATIC SWEEP FREQUENCY GENERATOR AND RECEIVER

The Model 2000 plug-in module, our first of the series, has an internal sine wave generator and receive circuitry for automatically creating amplitude versus frequency response plots on the UREI Model 200 X-Y Plotter. The Model 2000 features a unique Slope Sense\* circuit which automatically slows the sweep rate when rapid amplitude changes occur, and then resumes its normal rate afterwards.

Both Models 2010 and 2000 plot signals from 20 Hz to 20 kHz on K&E or DIN Audio Response Graph paper with 0.05 db resolution and a dynamic range of over 60 db. Vertical scaling is switchable from centimeters to inches. (UREI quality, of course.) Available from your UREI dealer.



\*patent applied for.



MODEL 2010



MODEL 2000

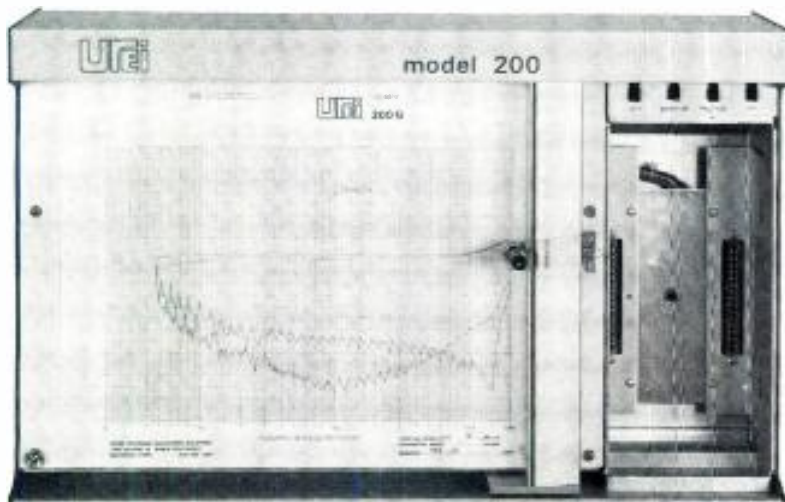

8460 San Fernando Road, Sun Valley, California 91352 (213) 767-1000

Exclusive export agent: Gotham Export Corporation, New York

Circle 43 on Reader Service Card

www.americanradiohistory.com

letters (cont.)

addition, 4-5 dB of noise pump-up is noticed in very quiet passages. We would, however, agree with Mr. Gibb that the quality degradation is less pronounced than the degradation caused by conventional processing.

Mr. Gibb's comments on the waste of spectrum capacity when unprocessed 75 uS material is broadcast are well taken, and scarcely require further comment. Mr. Purcell's claim that a station's patching out its processing during the classical music hour resulted in improved quality and no overmodulation is indicative of blind luck; this writer fully believes the claim of improved quality, but a single cymbal crash or strong sibilant can result in 250 per cent modulation and splatter into adjacent channels before the operator (probably a nervous wreck!) can lunge for the fader and cause a far more blatant level change than any well-designed limiter! Even Dolby recognizes the need for a "transmitter protection limiter" as a safety valve to prevent overmodulation, even if gain reduction is never produced under normal conditions.

To summarize: This writer believes that some compression best serves the audience in a vast majority of cases. That the desirability of Dolby-f.m. transmission depends entirely upon the percentage of the audience equipped with Dolby receivers, and that the simple "purist" attitude is hopelessly outmoded and naive, given the nature of f.m. radio's 1977 audience.

ROBERT ORBAN  
Chief Engineer  
Orban Associates, Inc.  
San Francisco, Ca.

## Calendar

### OCTOBER

- 15-19 **Instrumentation - Automation Conference.** Philadelphia Civic Center, Philadelphia, Pa. Contact: Instrument Society of America, 400 Stanwix St., Pittsburgh, Pa. 15222. (412) 281-3171.
- 11-12 **Sound Business Show** (ERA Consumer Products Div.) Rodger Young Ctr., Los Angeles, Ca. Contact: Alan Gediman, Marshank Sales (213) 559-2591.
- 16-21 **SMPTE Technical Conference & Equipment Exhibit.** Century Plaza Hotel, Los Angeles, Ca. Contact: SMPTE, 862 Scarsdale Ave., Scarsdale, N.Y. 10583.

(continued)



# Better stereo records are the result of better playback pick-ups

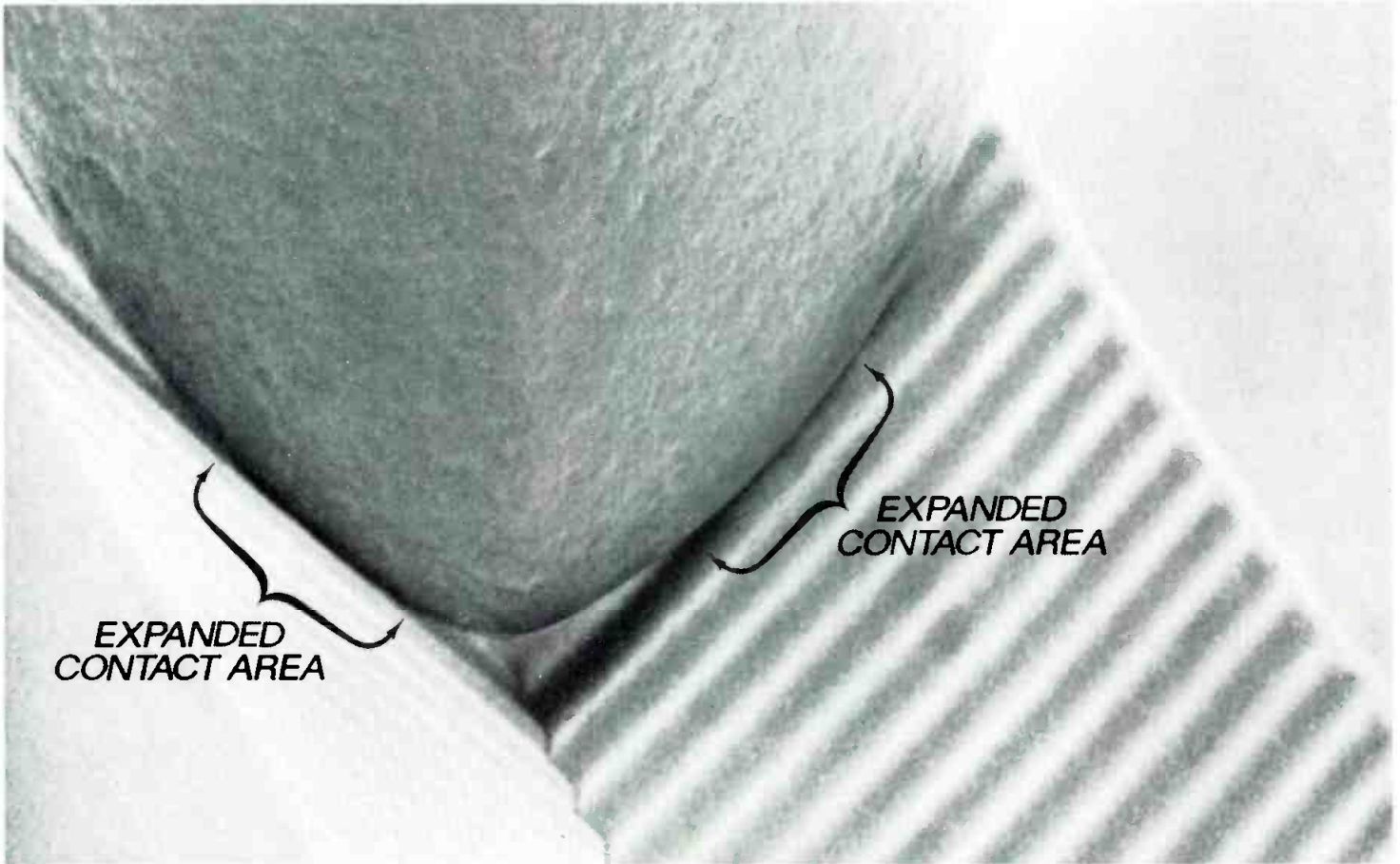

© Stanton Magnetics, Inc., 1977

Scanning Electron Beam Microscope photo of Stereohedron Stylus; 2000 times magnification. Brackets point out wider contact area.

## Enter the New Professional Calibration Standard, Stanton's 881S



Mike Reese of the famous Mastering Lab in Los Angeles says: "While maintaining the Calibration Standard, the 881S sets new levels for tracking and high frequency response. It's an audible improvement. We use the 881S exclusively for calibration and evaluation in our operation."

The recording engineer can only produce a product as good as his ability to analyze it. Such analysis is best accomplished through the use of a playback pick-up. Hence, better records are the result of better playback pick-up. Naturally, a calibrated pick-up is essential.

There is an additional dimension to Stanton's new Professional Calibration Standard cartridges. They are designed for maximum record protection. This requires a brand new tip shape, the Stereohedron®, which was developed for not only better sound characteristics but also the gentlest possible treatment of the record groove. This cartridge possesses a revolutionary new magnet made of an exotic rare earth compound which, because of its enormous power, is far smaller than ordinary magnets.

Stanton guarantees each 881S to meet the specifications within exacting limits. The most meaningful warranty possible, individual calibration test results, come packed with each unit.

Whether your usage involves recording, broadcasting or home entertainment, your choice should be the choice of the professionals... the STANTON 881S.

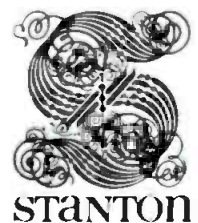

For further information write to Stanton Magnetics, Terminal Drive, Plainview, New York 11803

This new Stanton advertisement will appear in major consumer publications.

Circle 47 on Reader Service Card  
www.americanradiohistory.com

calendar (cont.)

- 18-20 **Western Educational Society for Telecommunications Conference.** Harrah's Hotel, Reno, Nevada. Contact: Wendell H. Dodds, Radio-Television Ctr., University of Nevada 89557.
- 25-26 **New York University R&D Management Seminar.** Chicago, Ill. Contact: Heidi Kaplan, New York Management Center, 360 Lexington Ave., New York, N.Y. 10017. (212) 953-7262.

### NOVEMBER

- 2-9 **Synergetic Seminar,** Washington, D.C. Contact: Don Davis, Synergetic Audio Concepts, P.O. Box 1134, Tustin, Ca. 92680. (714) 838-2288.
- 2-6 **Dixie Electronics Representatives Convention.** Boca Raton Hotel & Club, Boca Raton, Fla. Contact: Kimball P. Magee, Dixie Elec. Reps. Inc. 1611 Perimeter Center E., Atlanta, Ga. 30346.
- 4-7 **Audio Engineering Society Convention and Show,** Waldorf-Astoria, New York, N.Y. Contact: A.E.S., 60 E. 42nd St., Rm. 449, New York, N.Y. 10017. (212) 661-8528.
- 6 **Start Your Own Business Seminar,** Chicago, Ill. Contact: Heidi Kaplan, New York Management Center, 360 Lexington Ave., N.Y.C. 10017.
- 7-8 **N.Y.U. R & D Seminar.** Los Angeles, Ca. Contact: Heidi E. Kaplan, New York Management Center, 360 Lexington Ave., New York, N.Y. 10017. (212) 953-7262.
- 10 **Society of Broadcasting Engineers, N.Y. Chapter meeting.** WQXR Presentation Theater, N.Y. Times Building, 230 W. 43rd St., New York, N.Y. 7:30 p.m. (Cafeteria dinner available.) Speaker: Ron Simon. Contact Tom Padwa.
- 14-17 **B&K Seminar, Acoustical Materials.** Cleveland, Ohio. Contact: B&K Instruments, 5111 W. 164th St., Cleveland, Ohio 44142. (216) 267-4800.
- 15-17 **Synergetic Seminar.** Nashville, Tenn. See above.
- 16-19 **Videodisc/Home Video Programming Conference,** Loeb Conference Facility, N.Y.U., New York. Contact: Robert Hamilton, 24 Washington Sq. N., New York, N.Y. 10011. (212) 982-5244. ■

# dbx K9-22 Kard converts your Dolby\* "A"



to dbx noise elimination in a few minutes with complete plug-in interchangeability and no wiring changes

## advantages of dbx K9-22 Kard

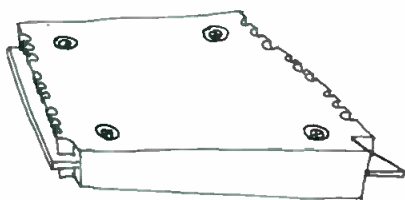

30dB noise reduction  
10dB additional headroom  
over 100dB dynamic range  
no level match tones

## K9-22 Kard Accessories



K-360 Kover replaces standard Dolby 260 or 261 front panel cover; window lets you see whether you've got K9-22 Kards or Dolby cards in the system.



carryin' cases, weather-proof aluminum flight cases by Halliburton, let you take your K9-22 Kards along as extra baggage, provide secure storage for unused cards, model KK-18 holds up to 18 cards, model KK-38 holds up to 38 cards

You can add dbx to your existing Dolby "A" system for about 40% of the cost of a free standing noise reduction system. for complete information contact:

\*dolby is a trade mark of Dolby Laboratories

dbx, Incorporated, 71 Chapel Street, Newton, Massachusetts 02195 • 617/964-3210



# Unplug it with Ivie.

Ivie just eliminated the power line cord on professional audio test equipment. Our state-of-the-art designs are going portable. You can leave those heavy boxes and their extension cords in the office, because the new IE-10A Audio Spectrum Analyzer puts audio analysis in the palm of your hand.

The IE-10A is an extremely versatile audio analyzer combining the power of a sound level meter with that of an octave bandwidth spectrum analyzer. Calibrated in both dB SPL and dBm, the unit measures a broad variety of signals quickly and accurately.

The built-in calibration microphone is equalized to the IE-10A case to ensure flatness. An external input is provided for on-line signal monitoring and use with other types of microphones.

From the equalization of rooms, speakers and tape recorders to noise analysis and sound pressure level testing, the IE-10A is an audio pro. Using inexpensive accessories the IE-10A will also measure amplifier power, voltage and total harmonic distortion.

If you think our specifications are impressive . . . you should check out the prices! So get "unplugged" with an IE-10A. Ask us for a brochure, or see your local Ivie dealer for a demonstration.

## Spec Briefs

Frequency Range 22Hz - 22KHz.  
45 dB "on-screen" display range.  
Ten octave channels w/160 LEDs.  
Selectable 1, 2 or 3 dB resolution.  
Calibrated 45 to 140 dB SPL (A or C).  
Calibrated - 116 to +9 dBm.  
Rechargeable Nickel - Cadmium batteries.  
Weight is 15 ozs. (430 gms).

For free literature and data, contact:



IVIE ELECTRONICS, INC.  
500 West 1200 South  
Orem, Utah 84057  
(801) 224-1800

Or return the reader service card.

The IE-10A . . .  
a complete audio analysis system  
in the palm of your hand.



The Ivie family is growing with a powerful new set of accessories. Pictured above is the IE-20A Pink Noise Generator and the IE-15A Harmonic Distortion Analyzer is shown below.



# Para-Power (Parametric Equalizers by SAE)



SAE has long been involved in the field of tone equalization. From our pioneering efforts in variable turn over tone controls to our more recent advancements in graphic equalizers, we have continually searched for and developed more flexible and responsive tone networks. From these efforts comes a new powerful tool in tone equalization — the Parametric Equalizer. Now you have the power of precise control.

Our 2800 Dual Four-Band and 1800 Dual Two-Band Parametrics offer you controls that not only cut and boost, but also vary the bandwidth and tune the center frequency of any segment of the audio range. With this unique flexibility, any problem can be overcome precisely, and any effect created precisely.

With either of these equalizers, you have the power to correct any listening environment or overcome any listening problems that you are faced with. Whether you need a third octave notch filter, tailored bandwidth to resurrect a vocalist, or a tailored cut to bury an overbearing bass, the control flexibility of Parametric Equalizers can fill these needs and many more. And of course, as with all SAE products, they offer the highest in sonic performance and equality of construction.

**SAE**  
Scientific Audio Electronics, Inc.  
P.O. Box 60271 Terminal Annex, Los Angeles, CA 90060

PATRICK S. FINNEGAN

# db Broadcast Sound

## Audio Metering

• Audio signals that pass through the station's audio system must be controlled so that they are maintained within the system's parameters. To maintain control of these signals, we need more than aural monitoring—we need a quantitative measuring device, such as a meter. This month we will discuss some of the factors involved in metering audio and some of the ways in which this can be done.

### THE dB

dB is a well used term, but in itself it has no value in the sense of voltage or current measurements. The dB is a mathematical ratio between two power levels. For example, 3 dB is an expression for the ratio between 1 watt and 2 watts, but it is also the expression of the ratio between 1,000 watts and 2,000 watts, or yet, between 4 watts and 2 watts. Thus, it is only the *ratio* which is expressed in the dB value, and this can be an expression of power gain or power loss.

Of course, there is more to the obtaining of the dB value than the power ratio itself. The numerical dB value is derived from a logarithmic formula:  $dB = 10 \log_{10} P1/P2$ . The value then, is ten times the logarithm of the power ratio. We can also express voltage or current ratios in dB's—just so long as

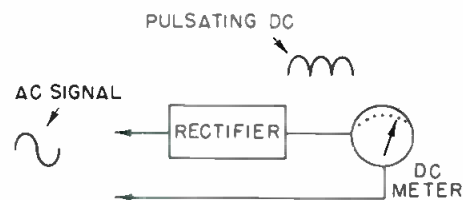

Figure 1. The usual a.c. voltmeter is actually a d.c. meter movement with a rectifier arrangement.

the impedance is the same in both factors of the ratio. The formula then becomes:  $dB = 20 \log_{10} E1/E2$  or  $11/12$ .

If we want the dB value to take on a more specific meaning, then we must reference the measurements to some value, for example, 1 milliwatt, 1 microvolt, 1 kilowatt, etc. The standard program distribution reference in broadcasting is one milliwatt (m), and this is further referenced by defining the circuit impedance of 600 ohms. The reference value then is 0 dBm.

### A.C. VOLTMETER

In the more general measurement

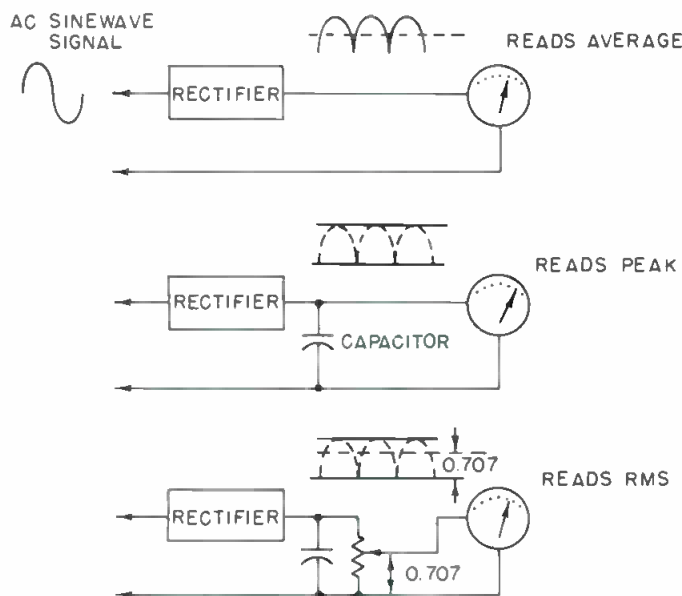
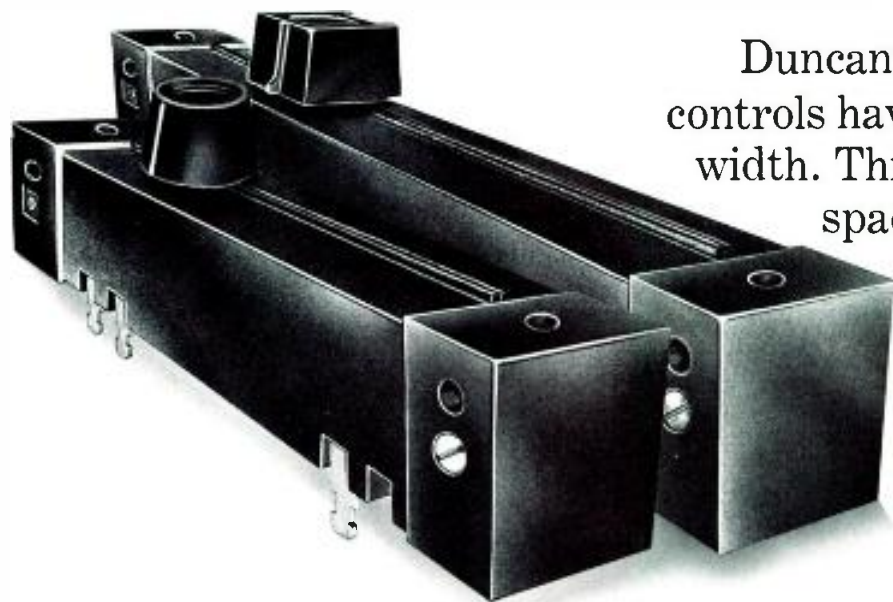

Figure 2. The a.c. voltmeter will read only the average value of the sine wave; it must be modified to read peak value or rms value.

# We're narrow-minded, price-conscious and sticklers for quality.



Duncan's new Series 400 Slideline® controls have a remarkably narrow  $\frac{5}{8}$ " width. This design not only saves you space—it will save you money.

Quality and performance have been proven beyond question. The element, RESOLON conductive plastic, has long-life and low-noise character-

istics that are recognized throughout the industry. In fact, RESOLON has a seven-year, failure-free record in the audio/broadcast field.

Among other advantages unique to Series 400 are: extremely low profile, linear and audio outputs, plus single or dual channels. Their high-impact cases are durable, solvent-resistant plastic with built-in moisture and dust seal. Offered in two stroke lengths, Model 421 has a  $2\frac{3}{4}$ " travel; Model 441 a  $4\frac{1}{4}$ " travel.

Terminals are solder type flat lugs, which accept quick-connect receptacles. Models 422 and 442 have printed circuit pins.

Temperature range/ $-55^{\circ}\text{C}$  to  $+125^{\circ}\text{C}$ .

In addition, internal SPST or DPST

cue switches with GOLDPLATED CONTACTS are available with no increase in package size. Center taps are available (linear units only). These controls may be obtained with metric mounting (Series M400). Call or write today for literature with complete information.



## Duncan Series 400 Conductive Plastic Slideline Controls

**DUNCAN ELECTRONICS**  
SUBSIDIARY

SYSTRON  +  DONNER

2865 Fairview Road • Costa Mesa, California 92626  
PHONE: (714) 545-8261 • TWX 910-595-1128

Circle 34 on Reader Service Card

[www.americanradiohistory.com](http://www.americanradiohistory.com)



Meet Crown DC-300 amp, serial number 2131. It's owned by Fanfare, who puts together sound systems.

Since 2131 was built, it has worked hard professionally, most of the time on the road. In and out of trucks, in and out of racks, in and out of dust, wind, rain and sun.

Once it was in a truck that rolled over three times returning from a tour. 2131 went right through the roof and landed in a puddle where Fanfare found it hours later.

That was five years ago. After cleaning and adjustment, it went right back to work, to provide

more years of trouble-free, professional service.

Almost every sound engineer has his own favorite "Crown-can-take-it" story. Each one is a testimonial to the rugged, reliable, distortion-free performance built into each Crown amp.

Build that same performance into your next sound system. Specify Crown.

Write us today for a copy of our latest spec sheets.



## broadcast sound (cont.)

instruments, the meter movement is not an a.c. movement, but a d.c. meter. The a.c. signal voltage is first rectified and the d.c. output measured with a d.c. meter movement. This rectifier may be within the meter case or external to the meter. Panel meters, for example, usually have the rectifier within the case, while larger test instruments have an external rectifier.

This meter arrangement can only read the average value of the a.c. voltage. Because of mechanical inertia, the meter cannot follow the pulsating current peaks out of the rectifier, so it will simply average out the value. To make this a peak-indicating instrument, a capacitor is needed, following the rectifier. The value of this capacitor must be many times the value of the a.c. signal frequency so that it can charge up to the peak value of the rectified pulses. And if we want the meter to indicate in rms value, then a resistor divider must follow the capacitor. This will divide the voltage so that exactly 0.707 of the peak value is metered.

All the foregoing factors depend upon a single frequency, "pure" sine wave which has a very low percentage of distortion and harmonic components. The basic meter circuit is accurate only at power line (60 Hz) frequency and is "usable" up to 800 Hz. To measure sine wave tones in the audio region (or higher), compensation must be added or incorporated into the meter so as to *broadband* its response.

### AUDIO SIGNALS

An audio signal may be either a single frequency sine wave, or it may be a program signal made up of a variety of waveforms according to the particular sounds it represents at any instant. The regular a.c. voltmeter will read neither of these signals with any degree of accuracy. For the tones, it simply doesn't have the necessary wideband response, and for program, the waveform is too complex. To measure audio sine waves, the meter must have the compensation to provide it with the necessary bandpass. But to measure program waveforms, more yet is required.

To distinguish between sine wave measurement and program measurement, a different term is used—the *volume unit* (vu). This term only has meaning to measurement of program audio, and to measure this program audio, a special a.c. meter is required—the vu meter. Although the term *vu* is a standard term with a standard meaning and has been around for

# Introducing the Technics ST-9030 tuner. Purists would feel better if it cost over \$1,000.



To some, tuners that offer 0.08% THD, 50 dB stereo separation, a capture ratio of 0.8 dB and waveform fidelity should demand a price tag of over \$1,000. But with the ST-9030 this performance can be yours for under \$400.\*

That's quite a feat for a tuner. But then the ST-9030 is quite a tuner. It has two completely independent IF circuits: A narrow band, for ultra-sharp selectivity. And a wide band, for ultra-high separation and ultra-low distortion. It even selects the right band, depending on reception conditions, automatically.

Both bands give you the same extended flat frequency response. Because, unlike conventional tuners, the ST-9030 utilizes an electronic pilot cancel circuit that cuts the pilot signal, without cutting any of the high end. It's ingenious. And a Technics innovation.

The Technics ST-9030 has one of the quietest, most sensitive front ends of any tuner. With an advanced linear frequency 8-ganged tuning capacitor and 3 double-tuned circuits, plus dual gate MOS

FETs in the 2-stage RF amplifier and balanced mixer circuit. What's more, there's a servo tuning circuit that locks into the tuned frequency, regardless of minor fluctuations. The result: Negligible drift distortion and maximum stereo separation.

Technics ST-9030. Compare specifications. Compare prices. And you'll realize there's really no comparison.

THD (stereo): Wide—0.08% (1kHz). Narrow—0.3% (1kHz). S/N: 80 dB. FREQUENCY RESPONSE: 20Hz—18 kHz  $\pm$  0.1,  $-$  0.5 dB. SELECTIVITY: Wide—25 dB. Narrow—90 dB. CAPTURE RATIO: Wide—0.8 dB. Narrow—2.0 dB. IF, IMAGE and SPURIOUS RESPONSE REJECTIONS (98 mHz): 135 dB. AM SUPPRESSION (wide): 58 dB. STEREO SEPARATION (1 kHz): Wide—50 dB. Narrow—40 dB. CARRIER LEAK: Variable  $-$  65 dB (19 kHz). Fixed  $-$  70 dB (19 kHz, 38 kHz). SUGGESTED RETAIL PRICE: \$399.95\*

Technics ST-9030. A rare combination of audio technology. A new standard of audio excellence.

\*Technics recommended price, but actual retail price will be set by dealers.

**Technics** Professional Series  
by Panasonic

Circle 41 on Reader Service Card

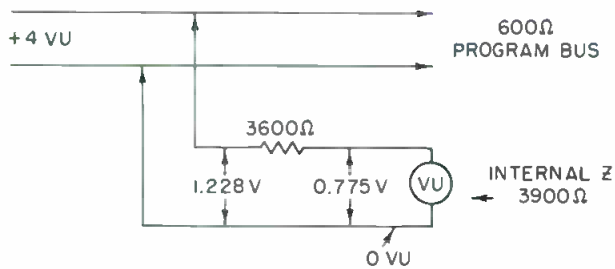

**Figure 3.** For normal program metering, the vu meter will always have a minimum of 3600 ohms series resistance in the path of the meter.

## broadcast sound (cont.)

many years, the term dB is commonly applied by engineers when referring to either program levels or sine wave levels (old habits are hard to break). There is no real harm in such usage, so long as those using the terms understand the difference in meaning between the two.

## THE VU METER

The vu meter is a special a.c. voltmeter that incorporates the rectifier and capacity to make it read peaks, but it also contains special damping and logarithmic characteristics so that it corresponds more to the manner in which the human ear responds to sounds. Thus, the vu meter is really a quasi-peak indicating device. True signal peaks are many dB higher than the peaks indicated by the instrument. These peaks can be as much as 20 dB higher in some particular instances, although the more usual difference is 8-12 dB higher.

The meter face has two scales: 0-100 for program peak measurement, and -20 to +3 for sine wave measurement. On sine waves, the vu meter (0 vu) corresponds to 0 dBm, that is, 1 milliwatt in a 600 ohm circuit. This is also an rms voltage of 0.775 volts in the circuit.

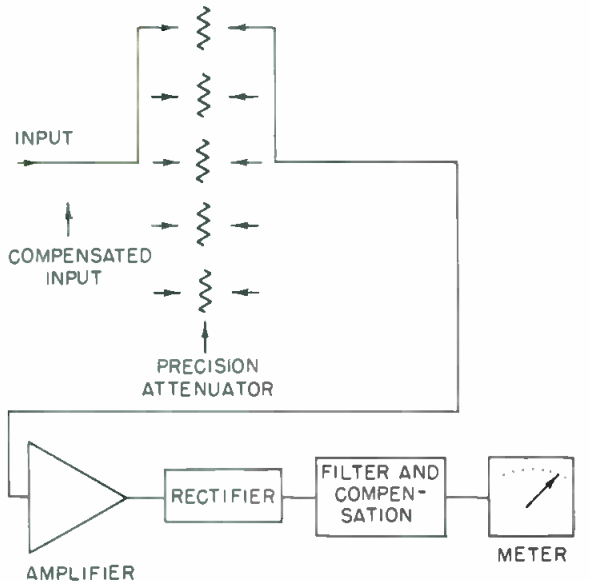

**Figure 4.** The audio voltmeter (test instrument) is more complicated than the panel meter.

## PADS

The internal impedance of the vu meter is 3,900 ohms, and if placed directly across a 600 ohm circuit, it will load the circuit slightly. So a series resistor of 3,600 ohms is always used with the meter to avoid these loading effects. This resistor also lowers the actual voltage to the meter circuit itself by 4 dB. For program monitoring then, the resistor is always used and the bus voltage increased to 1.228 volts as a standard program level, which corresponds to +4 vu. The meter itself will indicate 0 vu because the series resistor drops the voltage back to the milliwatt value of 0.775 volts. All this is a bit confusing, perhaps, but it really has relevance if we are interested in absolute signal amplitude values.

The vu meter is useful for transmission signal levels which are essentially high level signals. In most cases, besides the series resistor, additional "T" pads will be added ahead of the meter so as to reduce much higher levels to the range of the meter. But this is no different than the procedure with the regular multi-meter where we add series resistance to provide different ranges for the instrument. The difference, however, is that the vu meter doesn't have all the other scales

# Take a Waters slim-line space-saver

New MM thin-line faders are great for small portable mixers or lighting consoles. Only half the width of conventional faders, our 3/4-inch wide MM series lets you build a lot of mixing or control capability into a limited space. No performance compromise, either. You get Waters' proprietary Mystr<sup>®</sup> conductive plastic resistance elements. Glass-hard. Smooth. Long-lasting. You get Waters' computer-controlled curve shaping for highest tracking accuracy. And, you can choose 2 3/4-inch or 4-inch travel, 600 ohm or 10,000 ohm impedance; linear, audio, or true log characteristic. For complete information, circle the reader service card, or call Don Russell at (617) 358-2777.

**WATERS MANUFACTURING, INC.**  
LONGFELLOW CENTER, WAYLAND, MA 01778

Circle 44 on Reader Service Card

[www.americanradiohistory.com](http://www.americanradiohistory.com)



There are few DC amplifiers in the world  
with THD as low as 0.02%.  
But there's only one priced under \$400.

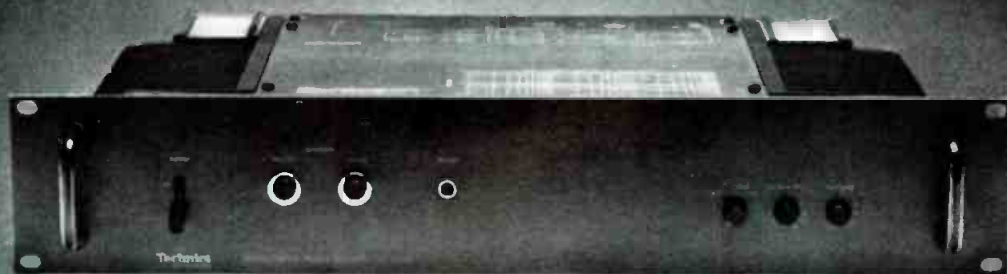

Introducing the Technics SE-9060 stereo/mono DC amplifier. Its concept is simple: amplification with inaudible distortion.

How Technics achieved this elusive goal is not quite so simple. Like the difference our newly developed dual FETs make in the current mirror-load differential amplifier. They enable the SE-9060 to achieve the DC stability necessary for the highest gain in the crucial first stage.

Another difference is the constant current load and current feedback used in the voltage amplifier to reduce distortion to a minimum. A minimum so low it is barely detectable with the most advanced measuring equipment.

But inaudible distortion was not the engineers' only goal. That's why Technics SE-9060 is a DC amplifier. Each amp section and the NFB loop is direct coupled without the use of any capacitors. So the SE-9060 not only has inaudible distortion, it also

boasts flat frequency response from DC to 100 kHz with almost nonexistent phase shift.

In addition to all the improvements in the amplifier stages, Technics also eliminated all signs of transient distortion with completely independent power supplies for each channel.

Compare specifications and prices. And you'll realize there's no comparison for the SE-9060.

POWER OUTPUT: 70 watts per channel (stereo), 180 watts (mono) min. RMS into 8 ohms from 20 Hz to 20 kHz with no more than 0.02% THD. INTERMODULATION DISTORTION (60 Hz: 7 kHz, 4: 1): 0.02%. FREQUENCY RESPONSE: DC-100 kHz, +0 dB, -1 dB. POWER BANDWIDTH: 5 Hz-50 kHz, -3 dB. S/N: 120 dB (IHF A). RESIDUAL HUM & NOISE: 100  $\mu$ V. INPUT SENSITIVITY & IMPEDANCE: 1V/47k $\Omega$ . SUGGESTED RETAIL PRICE: \$399.95\*

Technics SE-9060. A rare combination of audio technology. A new standard of audio excellence.

\*Technics recommended price, but actual retail price will be set by dealers.

**Technics** Professional Series  
by Panasonic

Circle 48 on Reader Service Card

[www.americanradiohistory.com](http://www.americanradiohistory.com)

## broadcast sound (cont.)

to let the observer know at what range the bus is actually operating.

### TEST INSTRUMENTS

There are many occasions when the system will be checked and measured with sine wave audio tones from a signal generator. The meter used in this case will be a larger test instrument rather than the panel meter. This test instrument may be part of a noise distortion analyzer, or an individual audio voltmeter instrument. In either case, the voltmeter designed to measure a wide range of signal levels will be wideband, and of course, more complicated than the simple panel meter.

The test instrument will have internal amplifiers to raise very low signal levels up to a range the meter can indicate, will contain precision attenuator pads, a meter rectifier and appropriate compensation to make it wideband. The bandwidth of some of these meters is well over 150 kHz. All models are not alike, of course, so the operator should be acquainted with the model he uses. Even a quality instrument can produce incorrect results if the operator is not familiar with the instrument.

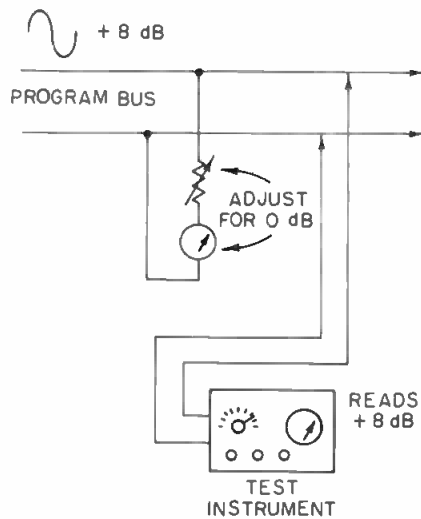

*Figure 5. When a vu meter is added to a circuit, set up the system with a regular test instrument. Then adjust the series resistor to make the added vu meter read zero dB.*

### ADD YOUR OWN

Metering throughout the system can be very helpful in setup, operations, and especially, troubleshooting problems. However, vu meters are not the most inexpensive items either. There are some "cheapies" that have vu meter scales—and some are so small it almost requires a magnifying glass to read them—but worst of all, some

do not indicate correctly either. That is, they do not have the proper band-pass nor the characteristics and thus produce incorrect indications. Unfortunately, some equipment units are equipped with such meters.

There may be one or two places in the system where more critical operational measurements are needed, and a vu meter can be added. This may be on-board or external to the circuit on a rack panel. You may add a precision pad or use a fixed (or variable) series resistor to bring the signal level into range of the meter. To set up such an arrangement, feed sine wave tone through the system, and measure the output of the circuit at that point with the larger audio voltmeter test instrument. Adjust the meter series resistor until the signal level reads 0 dB or whatever is required (on the new meter).

### METERING THE SYSTEM

A large audio system will generally have at least one vu metering panel mounted in a rack with the other audio equipment, or in a similar location. The metering panel is a standard commercial metering unit that contains a standard vu meter and precision attenuator pads which may be switched into the meter path. It contains the series 3600 ohm resistor in the first or second position of the switch. The first position may be a 1 mW position which puts the meter directly across the input circuit, but this is for absolute measurement of that level. For operational metering, the series resistor is in the path, so this position is +4 vu. Each of the other switch positions is marked according to the pad value. In effect, these calibrated pads do provide the additional scales necessary to indicate just what the bus signal level is when the meter is indicating 0 vu.

Such a metering panel can usually accept up to ten switch-selectable inputs, and thus can provide a rather wide view of system signal levels. This makes it very handy for setting up system levels, tests, and troubleshooting problems. If one of these switch positions is brought to a jack in the jackfield, then the meter panel's flexibility can be greatly expanded. With a jack, any other part of the system can be measured by patching it to the meter panel.

### SUMMARY

It is important to system operation that signal levels be measured and maintained throughout. More meaningful measurements can be made if the operator has a better understanding of the principles of the measuring device. ■

## STL Offers The Most Complete Selection Of Test Tapes Available Anywhere

If you are looking for precision test tapes, look no further. STL can serve all your needs with 150 mil cassette tapes, tapes in 1/4", 1/2", 1" and 2" sizes, flutter tapes and magnetic test films in Super-8 mm, 16 mm or 35 mm. STL gives you the most accurate reference possible in the widest range of formats. Order from us and find out where your system really is.

Write for a free brochure and the dealer in your area.

Distributed by Taber Manufacturing & Engineering Co.



STANDARD TAPE LABORATORY, Inc.

26120 Eden Landing Road / Suite 5  
Hayward, CA 94545  
(415) 786-3546

Introducing all the features you'd expect from a graphic and a parametric equalizer. At a price you don't. Under \$450.



A radical departure in circuit principles, Technics SH-9010 stereo universal frequency equalizer offers the experienced technician and demanding audiophile the flexibility of both a graphic and a parametric equalizer.

The five bands of each stereo channel have a center frequency that's independently variable. By turning the control knob below each slide pot, the center frequency can be varied up or down by as much as 1.6 octaves. So, unlike conventional equalizers with a fixed-center frequency, the SH-9010 has no frequency "blind spots." What's more, each band of the SH-9010 can adjust to overlap the adjacent band to further boost or attenuate a selected frequency width.

Incredible for the price? You're right. But what's even more incredible is that variable center frequency is just one of the SH-9010's advantages. Variable "Q" or bandwidth is another. With it you can broaden or

narrow any frequency band. Independently or both at the same time. Which means you can balance an entire string section or eliminate an annoying little hum.

Technics SH-9010. Compare specifications. Compare prices. And you'll agree there's no comparison.

THD: 0.02%. FREQUENCY RESPONSE: 10 Hz-20 kHz (+0, -0.2 dB). 10 Hz-70 kHz (+0, -3 dB). GAIN:  $0 \pm 1$  dB. S/N: 90 dB (IHF: A). BAND LEVEL CONTROL: +12 dB to -12 dB (5 elements x 2). CENTER FREQUENCY CONTROL: +1.6 oct. to -1.6 oct. BANDWIDTH (Q) CONTROL: 0.7 to 7.0. CENTER FREQUENCIES: 60 Hz (Variable 20 Hz ~ 180 Hz), 240 Hz (Variable 80 Hz ~ 720 Hz), 1 kHz (Variable 333 Hz ~ 3 kHz), 4 kHz (Variable 1.3 kHz ~ 12 kHz) and 16 kHz (Variable 5.3 kHz ~ 48 kHz). SUGGESTED RETAIL PRICE: \$449.95\*

Technics SH-9010. A rare combination of audio technology. A new standard of audio excellence.

\*Technics recommended price, but actual retail price will be set by dealers.

**Technics** Professional Series  
by Panasonic

Circle 18 on Reader Service Card

[www.americanradiohistory.com](http://www.americanradiohistory.com)

# 16 x 16 for \$7,950!



## tangent 3216

- 16 Submaster Assigns
- 22 LED Metering Arrays
- 3-Band Parametric EQ
- 2 Echo Sends
- 2 Cue Sends
- FET Switching
- Phase Reverse
- Phantom Microphone Powering
- Balanced In, Out, Return
- Gain (Mic Pre-Amp)
- LED Peak Indicators

Write for complete information on specifications and features!

**tangent**  
musical engineering  
2810 south 24th street  
phoenix, arizona 85034  
602-267-0653

NORMAN S. CROWHURST

## db Theory & Practice

• In the last column I showed the basic analogies for the simplest loudspeaker types. Do you find analogs help you? How about wave equations and formulas? If you want me to go through the D'Alembertian wave equation and derive the whole thing mathematically, have pity on the editor and typesetter of this magazine. Even if I wrote all the formulas correctly (which I would hesitate to assert I would, with confidence) either the editor or the typesetter would probably louse it up.

So I will suggest that those of you with sufficient mathematical bent, pursue that for yourself. Here we will address ourselves to an approach that most of us can assimilate more easily. For myself, while I can go through all that math if I want to, I find it easier to think the subject through logically, using math just to verify when I am not sure of something.

Speaking of that, before I get down to brass tacks, I remember an instance early in my career (more than 45 years ago now) when the company of which I was chief engineer wanted a better horn shaping than the well-known exponential. We retained a professional mathematician to work on the Bessel functions and all that jazz.

We gave him the parameters, and he went away and got to work on his figures and formulas. Some weeks later he came back with the "perfect"

solution. He had a configuration for the horn expansion that resulted in a throat acoustic impedance that was pure negative resistance. Now being just a professional mathematician, he had no idea what negative resistance might mean.

You can have positive and negative reactance, so why can't you have negative resistance? Of course, you can, and electronic engineers were familiar with the term: it occurs only in things that oscillate! So how could an acoustic horn, with only a throat, an expansion and a mouth, nothing to drive it, go into oscillation all by itself? And uniformly at all frequencies, yet?

We knew that was what his result meant, but to him the results were just figures, arrived at by his sure-fire mathematical procedures. The thought that he had made a mistake somewhere was out of the question! We argued with him for days, before he eventually consented to double check his work, when he found one of those silly mistakes that any of us can make but that such academic types hate to admit they do too, resulting in the irrational result.

That too is an attitude about which I have talked before in this column. generated by the notion that, if you follow the correct procedure, you are bound to come to the right result: no need to check anything! But now let us get back to the basics of loudspeakers.

(continued)

# Technics wants you to see what other speakers don't let you hear.

Look at the waveforms. Technics has achieved phase linearity as well as wide frequency response. And that means we've achieved state of the art in high fidelity: virtually a mirror image of music as it was originally played. We call it waveform fidelity. Julian Hirsch, in *June Popular Electronics*, calls the Technics Linear Phase SB-6000A "...one of the better sounding speaker systems we have heard in a long time!"

How did we do it? First by conducting exhaustive amplitude/phase studies in acoustically perfect chambers before designing and manufacturing each of the wide frequency/low distortion drivers. Then by developing a unique new phase-controlled crossover network

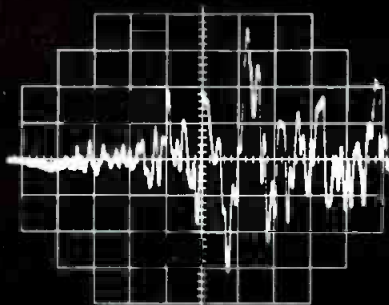

Live Piano Waveform.

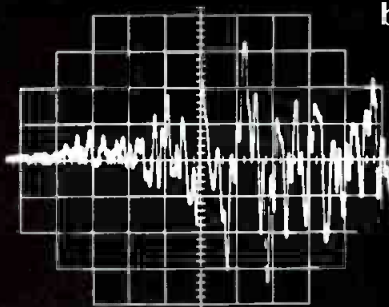

Piano Waveform reproduced by SB-7000A.

that compensates for the time delays caused by the wide range of frequencies in all music. While simultaneously compensating for the different acoustics of the woofer, midrange and tweeter. And finally by aligning each driver unit in the optimum acoustic position for precise linearity.

It's a lot of complicated engineering, but it all adds up to something very simple. Music as it was originally played. Nothing more, nothing less. And that's a lot.

Listen to Technics Linear Phase SB-7000A, SB-6000A and SB-5000A. They're now available for demonstration at selected audio dealers for very selective ears.

**Technics** Professional Series  
by Panasonic

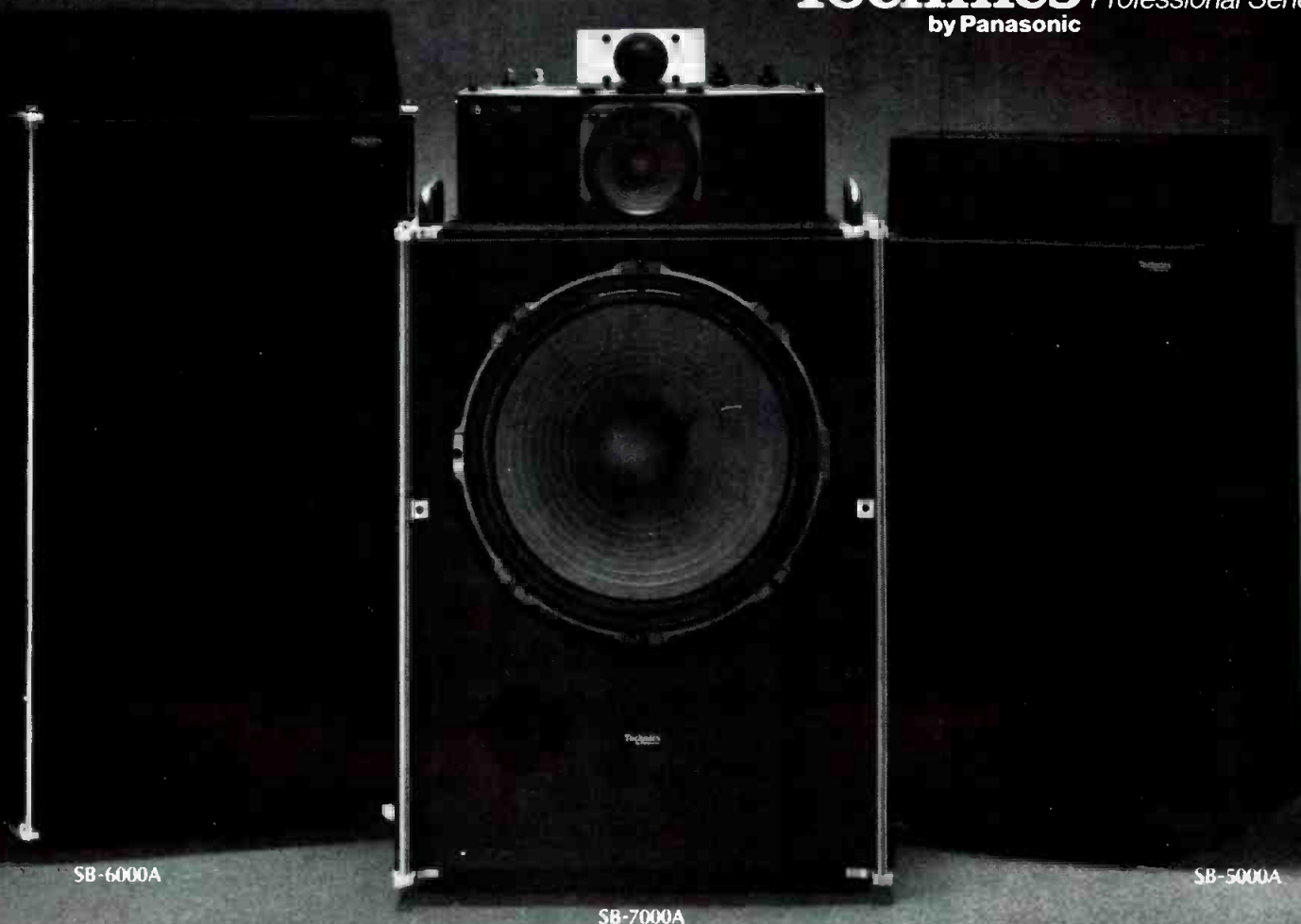

SB-6000A

SB-7000A

SB-5000A

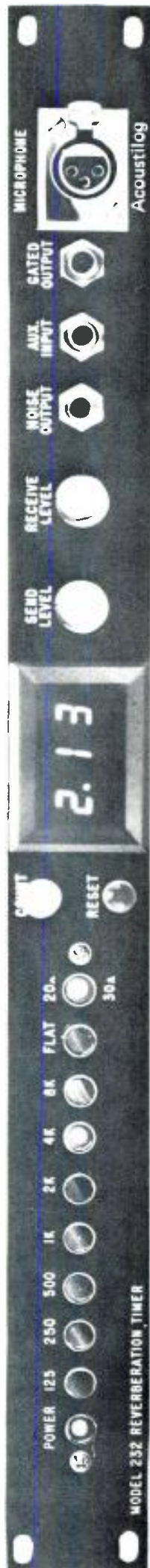

## MEASURE ROOM REVERBERATION TIME OF A CONTROL ROOM, ECHO CHAMBER, STUDIO OR CONCERT HALL

Reverberation time is the most important characteristic of a room's acoustics. And the Model 232 Reverb Timer is the fastest, most accurate system available to help you to correctly, **acoustically** improve a room's response. Exceptional accuracy: 3%; .01 to

9.99 sec. capability. Internal Pink Noise—±2 dB, 20-20k. Easily used by one person. Many optional features. Immediate delivery. Rental and consultation available. For price list, spec sheet, application notes, call or write.

# ACCOUSTILOG

19 MERCER STREET, NEW YORK, N.Y. 10013 [212] 925-1365

## theory and practice (cont.)

### BAFFLES

We are at the point where loudspeaker designers had realized that, whichever way you build a loudspeaker, to get good low frequency response it has got to be big, because low frequencies have such big waves—such long wavelengths. But public demand wanted something smaller, for the apartment dweller, for example, who wanted good bass but just did not have the room for a couple of massive corner horns.

The designers had found out about baffles, bending the sides back to make an open-backed box, which results in a good loudspeaker if you are prepared to sit right in front of it. Round at the sides or back, it is atrocious. So they closed the back in, to get the infinite baffle. This made the speaker more consistent in all directions, but removed the bass rather badly. The reason for this was that the air sealed in the back produced a stiffness, which is the opposite of a compliance, that swamped that of the spider or surround, that had previously limited low frequency movement.

So the resonance and thus the low frequency cut-off of the loudspeaker were pushed up in frequency. In those days, the only remedy that audio people knew for that was to boost it back again. This meant that, for frequencies below the new, rather high resonance (perhaps 200 to 300 hertz) more and more power was required to drive the speaker.

When you drove the speaker that much, it was subject to a lot of distortion. The low frequencies themselves were distorted because the long excursions needed drove the coil clear out of the magnetic air gap. So it had a strong drive in the middle of its "stroke," and a weak one at the ends. And of course, the spider also got very "tight" at the ends, adding to the distortion.

In addition to the low frequency distortion, the design produced a very strong intermodulation distortion of the SMPE kind (the "T" was not in it then!). When the cone was in mid-stroke at low frequency, the response throughout the rest of the range was normal. When it went to either extreme, the rest of the range was almost completely strangled.

### ACOUSTIC SUSPENSION

This set of facts was what got Ed Villchur puffing away on his pipe, to come up with the invention he called *acoustic suspension*. This was the first time a loudspeaker unit was designed

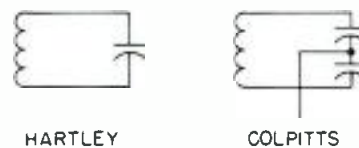

Figure 1. Hartley and Colpitts basic circuits.

radically different from the usual run, for the purpose of going into a particular design of box.

The unit had an extra long voice coil, with a very "floppy" suspension, so it could move way out of the magnetic gap, in the ordinary sense, before the number of turns in the magnetic field changed any. As it moved out, fresh turns moved in from the other side, getting rid of the non-linearity of drive force at large movements.

It also had a much heavier cone than its predecessors of similar size. The net result was that its unmounted resonance was down at one or two hertz. Putting it in the rather small box (for those days) brought the resonance up to around 30 to 35 hertz, which meant the bass unit's cut-off was around that frequency.

Above resonance, what controls cone movement is mass: the mass of the cone itself, and the mass of the air it drives, to form a sound wave. Making the cone much heavier resulted in loss of efficiency, because more of the energy is spent moving the cone and less of it in moving air that forms a sound wave. So the efficiency of an acoustic suspension speaker is quite low.

But the air cushion in back of the speaker is the main controlling force, around resonance, rather than the suspension that mechanically locates the coil and its cone for correct movement. The air cushion is far more linear than any mechanical suspension would be, so this virtually eliminates the other cause of distortion that occurred with infinite baffle types, overdriving at low frequency.

As that floppy diaphragm becomes even less effective at higher frequencies, the complete acoustic suspension unit comes with extra units for various parts of the high frequency range. This design had its faults, but it was a step forward.

Long before that, other designers had been making bass reflex speakers, usually by putting a "port" adjacent to the speaker hole. By proper design, the equivalent mass of air moving back and forth through the port, coupled with the cushion of air in the box, which also coupled with the loudspeaker cone, that had its own



## Rich sound. Without a rich price.

You would think an expert percussionist like Buddy Rich (who uses Shure SR equipment exclusively) has heard it all, but even he was amazed at the new Shure SR116 Speaker.

For the bear of this different drummer, it's been a whole different sound system. Buddy originally wanted the little SR116's because they packed a powerful punch in such a tight unit and they were perfect for the reed and brass sections.

Then, with a little experimentation, he found out these speakers could solve his biggest problem on stage —how to hear himself when

surrounded by all that brass. As Buddy says, "I wouldn't have any other unit at my side!"

And no wonder. No other 100-watt/8-ohm speaker system puts high efficiency, small size and smooth frequency response together so well. The portable SR116 (and the companion model SR112 permanent speaker) is 6 dB more sensitive than comparable-size units noted for their efficiency.

Shure Brothers Inc.  
222 Hartrey Ave.  
Evanston, IL 60204  
In Canada:

A. C. Simmonds & Sons Limited

### TECHNICORNER

The Shure SR116 is a two-way loudspeaker system utilizing a bass reflex enclosure and a 120° radial high frequency horn.

Frequency Response: 45 to 16,000 Hz.

Power Rating: 100 watts.

Impedance: 8 ohms.

Sound Pressure: EIA 48 dB, equivalent to 95.5 dB SPL at 1.2 m (4 ft.) with 1-watt input.

High Frequency Attenuator: 2 dB steps (+2 to -4).

Size: 400 mm H x 584 mm W x 381 mm D (15 3/4 in. x 23 in. x 15 in.).

Weight: 17.71 kg (39 lbs.).

Supplied Accessories: Snap-on protective cover, 15 m (50 ft.) cable.

Optional Accessories: A112A and A112B tilt and swivel brackets, and A112C slip on protective cover.



MANUFACTURERS OF HIGH FIDELITY COMPONENTS, MICROPHONES, SOUND SYSTEMS AND RELATED CIRCUITRY.

Circle 40 on Reader Service Card

[www.americanradiohistory.com](http://www.americanradiohistory.com)

# OCTAVE BAND ANALYZER

## THE NEW MODEL 150

### FEATURES

Simultaneous display - TEN one octave bands—31.5 Hz to 16 kHz  
• Light Emitting Diode readout • Meets ANSI 1.11, Class II for Octave Band Filter Sets • Fully calibrated in dBspl • Broadband dBspl • Line Input—calibrated in dBm • Flat or A-weighted measurements • Hand held—battery operated (rechargeable nickel-cadmium cells) • Precision microphone, carrying case, noise generator, battery charger included



### APPLICATIONS

- Sound system set-up
- Noise surveys
- Octave equalizer adjustment
- Speaker checkout
- Horn alignment
- Room surveys and speaker placement

ALSO: Active and passive equalizers • Other real time analyzers  
Dealer inquiries invited

White

Call or write today: WHITE INSTRUMENTS, INC.  
P.O. BOX 698 512/892-0752 Austin, Texas 78767

Circle 54 on Reader Service Card

Broadcast Products Division

# AUDIO

## Design Engineers, Studio Products

Have you expertise in these areas?—

**AUDIO PROCESSING EQUIPMENT**  
**TAPE RECORDING**

**AUDIO CONSOLES**  
**TAPE REPRODUCING EQUIPMENT**

Rapid and steady growth of our Division creates openings very attractive for career progress. We are one of the world's leading suppliers of radio and television broadcast systems, aggressively developing additional products; and a part of Harris, a successful corporation in many aspects of electronics. Corporate volume now exceeds \$600-million.

These positions require knowledge of low noise microphone and tape head preamplifiers, solid state switching techniques, electronic gain controlling, bias oscillator design, and other studio-related circuitry. Besides design, responsibilities may include material costing, project scheduling, and developmental budgeting.

Openings are at several levels, and recent graduates as well as those with 2-5 or more years of experience will be given careful consideration. Harris offers attractive salaries and excellent benefits, and our location affords very pleasant living.

Please direct resume in confidence, giving full pertinent details including salary progression, in confidence to Lawrence D. Carlstone, Professional Employment Supervisor, Harris Corporation, Broadcast Products Division, Quincy, Illinois 62301.



An Equal Opportunity Employer—Male and Female

Circle 45 on Reader Service Card

theory and practice (cont.)

mass and compliance, would all resonate at the same frequency.

### HARTLEY OSCILLATOR

If you come from the time of Hartley and Colpitts oscillators, the action was a bit like each of these. A Hartley oscillator uses a tapped coil, or inductor, which means it has a large amount of mutual inductance coupling. A Colpitts oscillator uses an untapped coil, with two capacitors across it, so it is like a tapped capacitance. But there is no mutual coupling between the two capacitors.

In the bass reflex and its successors, about which we will talk later, there is a little coupling between the two sources of radiation because they contribute to the same sound wave. But this is a lot less than in a tapped inductor, though more than there is between the capacitors of a Colpitts oscillator.

Whichever way you view it, at resonance the movement in the two masses, that of the cone and that of the air in the port, is in phase. So the two together resonate with the cushion of air in the box. Thus the bass reflex had "cheated" (as a lot of people thought of it before the acoustic suspension device came along to claim their attention) a little on the time-honored relationship between size and bass capability.

### BASS REFLEX

In the classic bass reflex, as we will henceforth call it, the energy radiated from both the cone and the port at resonance was about equal. Thus it doubled the sound wave radiated at that frequency, perhaps slightly more because each helped the other. But until the idea of loading was introduced, the acoustic suspension had the advantage in the race for bigger bass from smaller boxes.

Of course, the acoustic suspension did not get that advantage for free. It cost in efficiency. But then power was becoming easier to obtain elec-

## Copies of db

Copies of all issues of *db*—The Sound Engineering Magazine starting with the November 1967 issue are now available on 35 mm. microfilm. For further information or to place your order please write directly to:

University Microfilm, Inc.  
300 North Zeeb Road  
Ann Arbor, Michigan 48106





## THE MULTICELL:

We're not doing anything new, we're just doing it right.

### Often heard, but little understood

Nothing beats a multicell for pattern control. It has greater projection and throw capabilities than any other HF horn. But given the multicell as it has been produced over the last thirty years, it has brought an equal number of headaches. Besides being too heavy and structurally too weak for most applications, the advantage of coverage was often outweighed by excessive resonance and distortion, so that the use of a multicell often meant a choice of coverage over clarity.

We have a more sensible solution. Why not use a multicell that doesn't have the problems inherent in a metal horn?

### We're not doing anything new...

This is the Community 2×5, one of a family of multicells that includes a 2×4, a 1×2, and a Single Cell horn. We believe that it's a great series—not because we make them (although that would sway a lot of people), but because we've produced the old concept (which was essentially a great design) without all the disadvantages created by the old manufacturing

methods. How? By carefully constructing our multicells in hand-laminated fiberglass.

### We're just doing it right.

Our multicells are strong and weigh in at less than 30 pounds. The strength means solidity, which guarantees that the old kazoo-like tonal quality is no more. We carefully machine the cell ends where they meet under the manifold to minimize distortion. And by keeping our cells round instead of square, we've considerably reduced VHF lobing. While we were at it we added some extras: inherent weather-proofing, for one. You can paint a metal horn and weather-proof it ... for a while. But fiberglass will resist weather indefinitely. Another plus is that we make our horns individually to fit any commercially available loudspeaker—so that throat adapters are never necessary.

---

And now we've done it, you'll have to re-think the multicell's role in sound reinforcement. There's a myriad of applications that would benefit from the use of a Community multicell. Write to us for more information and detailed specifications.

# Community

COMMUNITY LIGHT & SOUND 5701 Grays Avenue, Philadelphia, PA 19143 (215) 727-0900

Circle 49 on Reader Service Card  
[www.americanradiohistory.com](http://www.americanradiohistory.com)

## theory and practice (cont.)

trically all the time, although the acoustic suspension did make the scene before solid state power was available, which may surprise newcomers. In those days we had tubes like beam tetrodes that got quite a lot of power, if you didn't mind the heat that came with them.

The acoustic suspension got away from the electrical overdrive that had been the only way to get the bass back, in the days of infinite baffles. Where, to get extended bass with an

infinite baffle, you had to boost the low-frequency output from the amplifier—quite a lot—with acoustic suspension, you did not have to tamper with the amplifier's response. This had other ramifications connected with the *damping factor*, that we have not mentioned yet.

Back in the early days of loudspeakers, hanging on from the old "moving iron" days, one trick to get efficiency up, or at least to make the unit sound as if it gave more sound for the money, was to fiddle with resonances in the mechanical design, which would make the speaker seem

to give more at judiciously-chosen frequencies.

Then the ad-men went into action, coining words to describe the sound of the loudspeaker, like "cathedral tone," "concert-hall," "warmth." and so forth. To people to whom audio was new, this had appeal. Only later did they discover that cathedral tone might not sound so appropriate when listening to a jazz group perform at the Hickory House.

Audio engineers in general—perhaps even before most loudspeaker designers in particular—began to realize that picking your resonances was not the way to go. What we needed was higher efficiency, with as few resonances as possible, or if you could not get rid of them completely, at least make them as unobtrusive as possible.

That led to the days when horns were king. The Klipschhorn was "top of the line." To many (including Paul Klipsch) there is still nothing to touch the old faithful horn. It has a higher efficiency than any other type of enclosure and suppresses undesirable resonances better than any other. For this reason, it sounds less like reproduction and more like the real thing than any other.

### STEREO

Almost inevitably, stereo changed that picture. People who were prepared to have one Klipschhorn, because it was the best, encountered difficulty accommodating two of them in their rooms. And now, for quadriphonic, they would need four! This trend put the pressure on smaller units, as did the trend toward smaller living rooms, and apartment living.

In my next column, I will pursue this interesting development of things a little further. ■

## NEW FROM LEADER FREQUENCY RESPONSE ANALYZER SYSTEM.

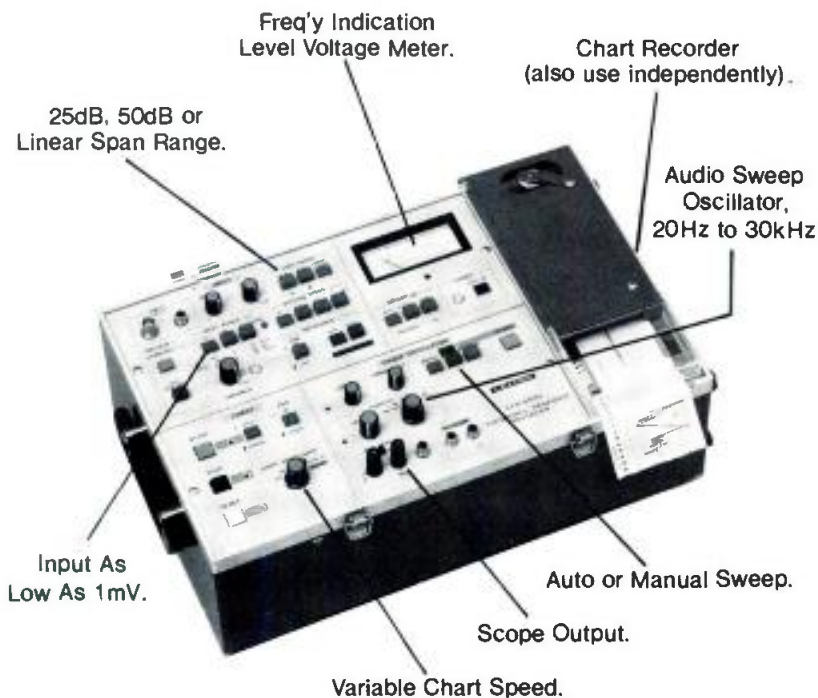

## Now, Hard Copy Readouts Of Audio System Performance . . .

- Tape recorder frequency response.
- Audio amplifier and receiver frequency response and signal-to-noise ratio.
- Cartridge frequency response.
- Wow & Flutter and drift.
- Filter design.
- Speaker design & evaluation.

**Model LFR-5600 . . . \$2,995.**  
See your distributor or write for details.

151 Dupont Street, Plainview, N.Y. 11803  
(516) 822-9300  
In Canada: Omnifonix Ltd. Montreal, Quebec

When Quality Counts . . .

**LEADER**  
Instruments Corp.

### MOVING?

Keep **db** coming  
without interruption!

Send in your  
new address *promptly*.

Enclose your old  
**db** mailing label, too.

Write to:

Eloise Beach, *Circ. Mgr.*  
**db** Magazine  
1120 Old Country Rd.  
Plainview, N.Y. 11803

# Tune-up, Preset and Change Scenes. In Real Time.

The Series 20A offers great flexibility in theatre sound mixing, television production, and concert sound reproduction.

The Series 20A is totally modular. That means you can have custom convenience at off-the-shelf prices. Because modularity lets you purchase only the modules you need. As your needs expand, you simply plug in more modules. And you can customize the arrangement for a particular show. Just plug the modules into any position on the chassis. No tools required.

The Series 20A simplifies your real time operation by allowing you to predetermine program content and distribution. Designed with human engineering in mind, the following features are provided.

- 4 chassis/enclosure sizes: 2½' with 21 module positions, 4' with 31, 5' with 39, and 6' with 47 positions.

- Up to 37 input channels, each switch selectable for mic and line level signals. Optional switching modules for selection of up to 48 additional remote inputs.
- Presettable (mute) circuit for each of four independent pre-sets. Any input can be assigned to any combination of the four muting circuits. Allows instantaneous changeover from one "scene" to another.
- Two complete foldback buses having level and switching controls at each input, with sub master controls.
- 3-Knob equalization on every input channel—with boost or cut.
- Unique datacable and roadmap configuration to interconnect Cetec's all solid-state printed circuits. Straightforward design provides simple plug-in module positioning.

For further information, contact Cetec Audio

A division of Cetec Corporation.

13035 Saticoy Street

No. Hollywood, CA 91605

Phone: (213) 875-1900 TWX: 9104992669

A division of Cetec Systems LTD.

U.K. Sapphire House, 16 Uxbridge Rd., Ealing,  
London W52BP

Phone: 01-579-9145 Telex: 837329

**Cetec**  
**audio**

For the educated ear.

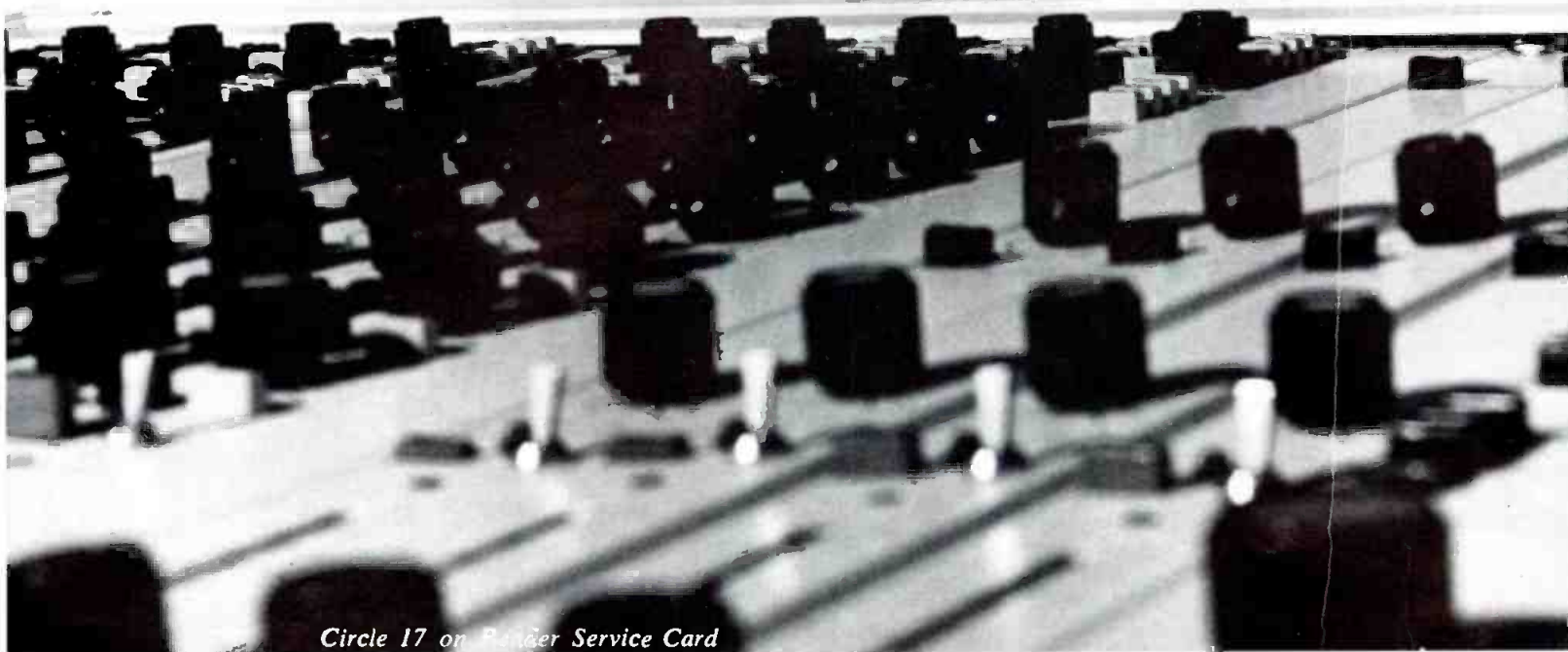
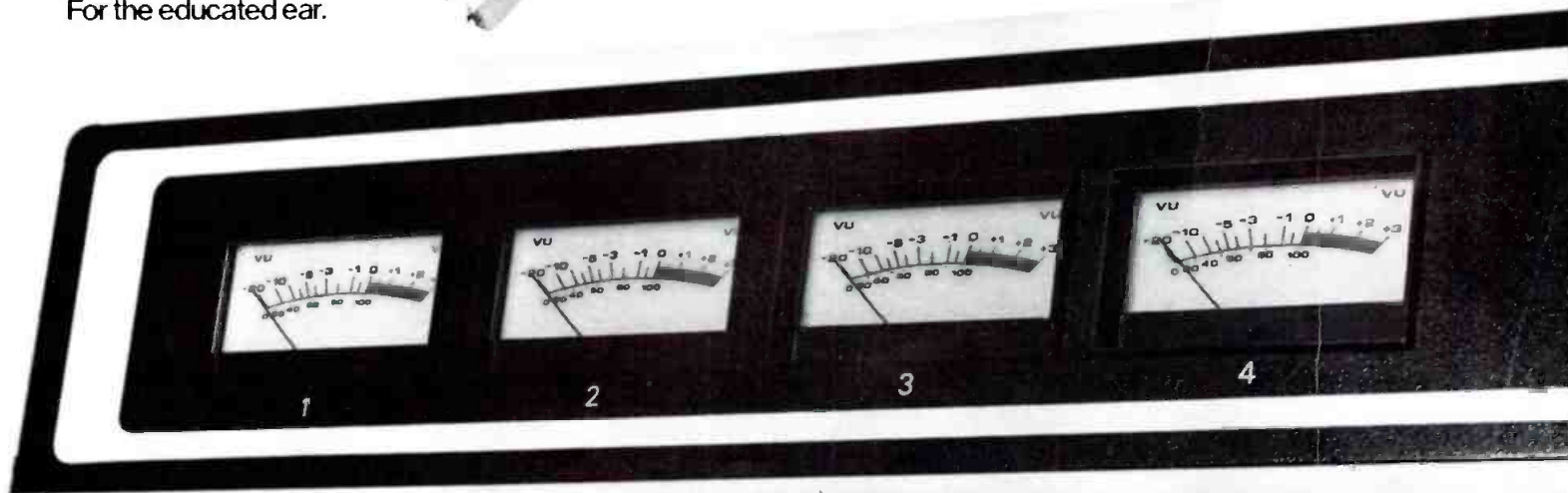
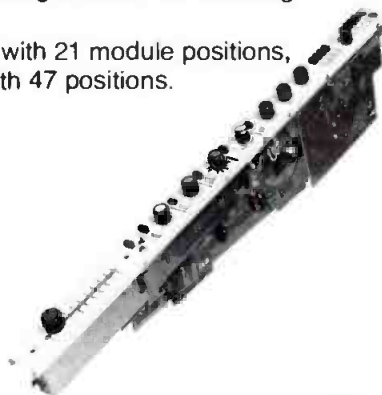

Circle 17 on Reader Service Card

## Cleanness vs. Loudness

• *Dear Sirs:*

*I have just finished reading the article in the June '77 issue of db by John Woram about audio in broadcasting. After finishing the article, I came away with the distinct impression that Mr. Woram thinks we broadcast engineers are just so many idiots with first class licenses, who can't hear anything above 5,000 Hz anyway. I think I am speaking for most of my colleagues when I say we are highly trained professionals in our field (I'll say more about that later). I personally decided I wanted to be a broadcast engineer while I was a sophomore in high school. I tailored the rest of my school courses toward that end, stressing math and sciences. I then spent four years getting a BSEE*

*degree so that I could do the work I wanted to do, and do it well. I think most other broadcast engineers also have spent time learning what they need to know to do their jobs well.*

*I will be the first to admit that the "cleanness" of the audio coming out of your typical home radio can in no way compare to the audio heard in a professional recording studio. How can anyone expect a \$30.00 radio with a four inch speaker to compare with what is heard in a studio with thousands of dollars worth of equipment? I think Mr. Woram must realize that we broadcasters, and the recording studios, are providing our respective services to two different groups of customers, who make different demands*

*of the product. Therefore, the product is going to be different, to meet the respective demands. The recording studio is selling its services to performers and composers, who have highly trained and critical ears, and demand a very "clean" product. The studio, therefore, to stay in business, must provide a "clean" sound to its customers, or they will go elsewhere.*

*In broadcasting, we are sending our signal out to the general public, and most members of this group do not have that highly trained and critical ear. When most people turn across the dial, they are more likely to stop and have a listen to a station that's loud, and a little bit dirty (which they probably can't tell anyway), rather than one that's very "clean," but barely audible. It follows that the more people you can entice to listen to your station, the more commercials you can sell, and the more you can charge for those commercials. This, for the commercial broadcaster, is what the whole ball game is all about. As for a listener-supported station, such as mine, it follows that if you have more listeners, you will have more listener-supporters.*

*To get our signal louder, we broadcast engineers use various combinations of compressors, peak limiters, equalizers, reverbs, etc. This audio processing not only makes our local signal louder, but also will tend to extend our listening area, and like I said before, this is what the whole ball game is all about. Of course, all this processing adds raspiness, distortion, loss of dynamic range, loss of frequency response, etc., to our signal. We broadcast engineers feel this is an undesirable, but necessary, side effect, which we try to minimize.*

*Mr. Woram thinks we should spend two or three times as much money for our equipment as we do now, to get stuff that's capable of a cleaner sound. I don't think it makes very good business sense to spend all that extra money for super "clean" audio equipment, then to have most of it lost in audio processing, and the rest not noticed by most of the listeners anyway. (Remem-*

### Tune In Performance

For Your Scully Studio Recorders.

#### Think Ferrite

10 Times Life • All Track Formats • 100's in Service  
Unconditional Warranty.

Ferrite Heads Available for all Professional Recorders.



SAKI MAGNETICS INCORPORATED  
(A California Corporation)

1649 12th Street • Santa Monica, California 90404 • (213) 451-8611

Circle 27 on Reader Service Card

www.americanradiohistory.com

# 8 to 18 from 749...

## **TROUPER I**

### Live Music Mixing System



#### INPUT FEATURES

- BALANCED MIC INPUTS
- HIGH Z LINE INPUTS
- IN/OUT JACKS
- 20dB ATTENUATION
- MONITOR SEND
- ECHO SEND
- 3-BAND GRAPHIC EQUALIZER
- SOLO/PREVIEW SWITCH
- LEVEL CONTROL

#### OUTPUT FEATURES

- SOLID STATE LED VU METER
- HEADPHONE JACK/LEVEL CONTROL
- BUILT IN SPRING REVERB
- HIGH/LOW CUT FILTERS
- HOUSE/MONITOR LEVEL CONTROLS
- HOUSE/MONITOR OUTS

See your local dealer or write for our free catalog:

**UNI-SYNC** INC

A BSR COMPANY  
742 Hampshire Rd.  
Westlake Village, CA 91361  
(805) 497-0766

**TROUPER I Live Music Mixing System, expandable from 8 inputs (\$749 suggested retail value) to 18 inputs (\$1447 suggested retail value).**

**A COUPLE dB OF TAPE HISS  
PROBABLY WON'T MAKE A BOMB  
OUT OF A HIT.**

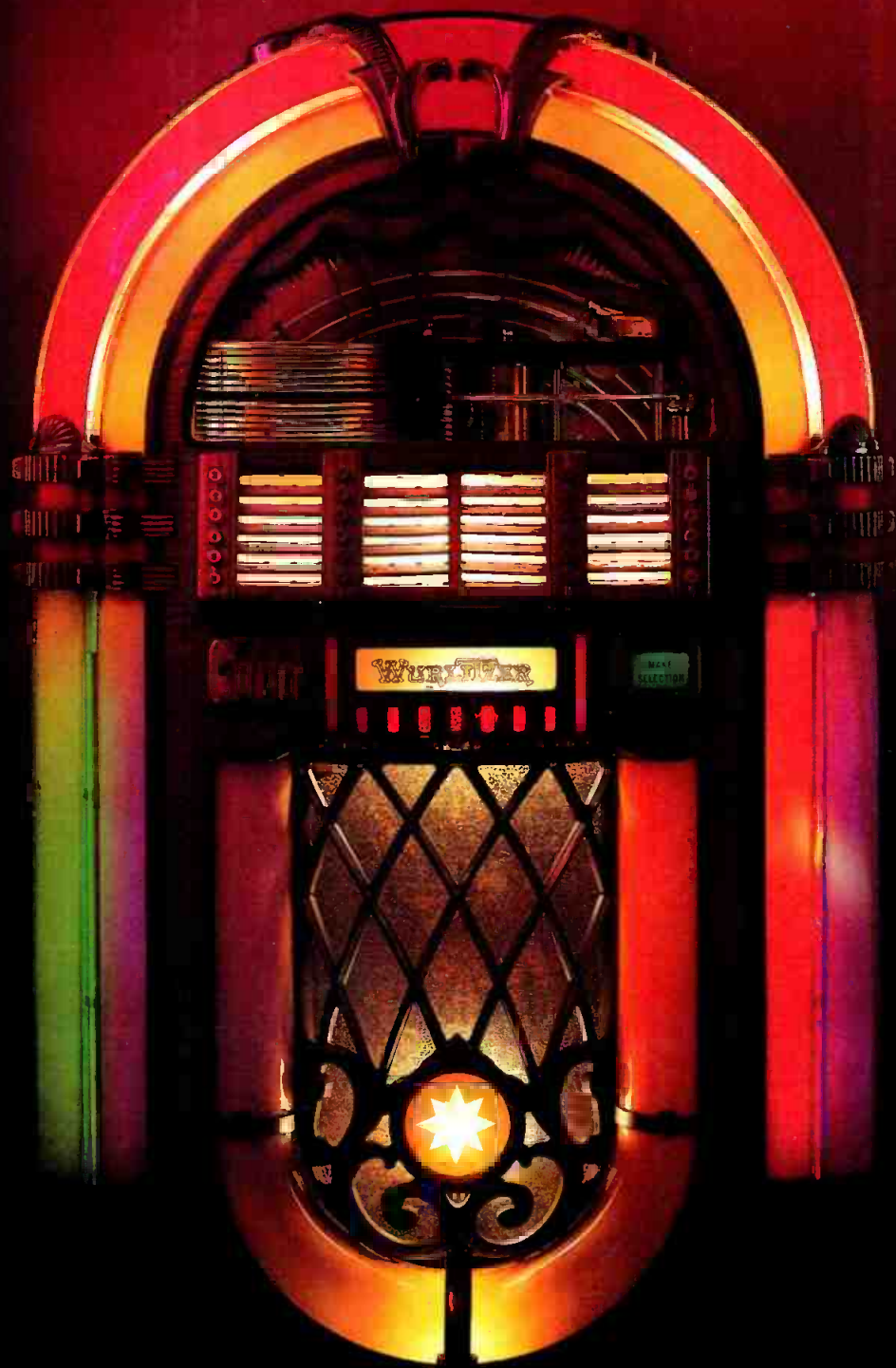

# BUT SOONER OR LATER YOU'RE GONNA HAVE TO CLEAN UP YOUR ACT.

## WHY LIMIT YOURSELF WITH MASTERING TAPE?

You won't catch a professional racedriver putting cheap gas into his Lotus. It's just dumb.

And the same holds true in the studio. With all that heavy machinery and expensive talent, it makes no sense to compromise on your mastering tape.

## TODAY'S SCOTCH 250 IS THE STATE OF THE ART.

With 250 you get far less tape noise. Considerably more high end clarity. Our exclusive oxide formulation and application reduces Mod noise. And when you add all that to dbx or Dolby it's positively the cleanest sound around.

## SINCE WORDS ARE CHEAP, WE PUT 250 TO A ROUGH TEST.

Whatever the numbers or the meters say, it's your ears you should listen to. So we went to a very fussy, very fine engineer and asked him to devise a test to demonstrate the difference between 250 and our nearest competitor.

The guy first thought we were nuts.

"You're serious?" he asked. "I use 250. What if my test proves the other tape is cleaner?"

We gulped a little, and told him to go ahead. This test was bound to be expensive.

But it would also be worthless, if everything wasn't above-board. That's why we chose Tom Jung of Sound 80, Minneapolis, to put it together. You may have heard of him.

## THE TEST PROGRAM WAS RECORDED—ON TWIN MACHINES.

Jung, as we expected, left nothing to chance. On April 18, 1977 he recorded an original music program simultaneously on two 24-track MCI's fed by one console. One recorder was carefully optimized for 250. The other, just as carefully, for the competitor's tape.

Jung used NAB equalization at 15 ips. He really packed both tapes at 6db (370 nWb/m) over standard operating level—without a shred of noise reduction.

## THE TRUTH CAME OUT FIRST AT THE AES SHOW.

It was May 10, 1977 at the LA Hilton. For playback we set up identical machines (our own M79 24-tracks, this time) with Altec 19 speakers. Then we opened our doors.

For each group of engineers we played not only the full mix, but individual tracks, first on one machine, then the other.

## THERE WERE SOME WHO COULD NOT BELIEVE THEIR EARS.

"Play that bass track again!" they'd say. And we'd play it.

"Are you sure both tapes were recorded at the same level?" We assured them they were.

"Lemme hear the strings with the horns."

In three days close to 600 people heard our 20-minute demo.

## AND THE TRUTH IS...

We didn't find one engineer who didn't hear the difference in L.A. Ditto in Nashville, where the demo was repeated July 13 and 14.

You can simply pack more sound on Scotch 250 and still stay clean.

So the bottom line is this. Scotch 250 is cleaner tape. Sorry, Ampex.

## DON'T TAKE OUR WORD FOR IT. BRING YOUR EARS TO NEW YORK.

We'll repeat this "head-to-head confrontation of mastering tapes" at the AES Show on November 4 and 5. Hear for yourself that heavy sounds don't have to be muddy.

**3M**  
COMPANY

## CLEAN UP YOUR ACT WITH "SCOTCH" 250.



Be sure  
to attend...

## THE AUDIO ENGINEERING SOCIETY'S

58th  
Technical  
Meeting and  
Exhibition of  
Professional  
Equipment  
at the  
Waldorf-  
Astoria  
November 4-7

For details,  
write or phone:

AUDIO  
ENGINEERING  
SOCIETY

60 East 42nd Street  
New York, N.Y. 10017  
(212)661-8528  
and 661-2355

### the sync track (cont.)

*ber. that audio processing is something we must have.) As for the audio freak who doesn't like what he hears coming out of his radio, I'm sorry, but we must cater to the majority in our business, just like the recording studio engineer must cater to the majority in his.*

*I think what I'm trying to say is that if I went into a recording studio, and applied broadcast techniques to their operation, I think they would soon be out of business. By the same token, if a recording studio engineer went into a broadcast station and applied his techniques there, I think their business would also suffer.*

*In conclusion, I would like to say a broadcast station's audio is not as clean as a recording studio's—not because we broadcast engineers don't know any better—but because we are working with a trade-off of "cleanness" vs. "loudness," which is dictated to us by the "consumers" of our product, a trade-off the recording studio does not have to deal with.*

Well, it looks like I've done it again, as this recent letter from an f.m. station chief engineer indicates. But no, I don't think broadcast engineers are just so many idiots. As a matter of fact—if I had to bet on it—I'd say they were on the average, better-trained for their jobs than most recording engineers. In fact, one has to get that license for broadcast work, and there's no such thing in the recording business (despite what some "schools" like to imply).

However, just like the recording engineer, the broadcast engineer is often forced into doing something dumb by upper management, and it's these folks I was pointing my accusing pen at. In the broadcast business, this may be some top-drawer thinker who considers the broadcast audience as "just so many idiots." To me, only a moron would select a station based solely on its relative loudness. Yes, I agree that if the listener is aimlessly spinning his dial, he will be attracted to the loud station. However, once he hears what's happening there, he may move on in search of something a little better; something with a little more dynamic range and perhaps a little less distortion.

But, station management seems to think that the only thing that counts is "loud." If it's any comfort, the same sort of mentality often prevails in the recording studio. Many producers (and yes, gulp!, even engineers) think that if the studio doesn't have at least 16 or 24 tracks, it's just plain unusable.

So, we hear a lot of stuff on records that is simply wretched.

Before I infuriate another group of readers, let me point out that here I'm referring to the sound of the recording, not its musical content. Anyway, the technological atrocities that get committed to multi-track tape are another story, so let's get back to broadcasting.

### LESS—NOT MORE

I re-read the June Sync Track (I have a cast-iron stomach), and couldn't find any recommendations that the broadcaster should spend "two or three times as much for . . . equipment . . . to get stuff that's capable of a cleaner sound." As a matter of fact, why not spend two to three times *less* money? For some more on that line of reasoning, see Ronald W. Purcell's letter to the editor in the July issue of *db* (page 6-8). He says, "I've found that the best-sounding f.m. stations are *always* those with the least possible amount of equipment between turntable and transmitter—and all being of top quality." So, if you've got a certain amount of bucks to spend, why not spend it cleaning up the system, rather than screwing it up?

No, I don't mean reducing your station's coverage to listeners within the shadow of your transmitter. But, why not ease up just a bit on the signal processing? For example, is it *really* necessary to add artificial reverb to newscasts? (A note to foreign readers—No, I'm not kidding; some stations really do this).

There are probably no more idiots-per-capita in the listening audience than there are in broadcast and recording studio control rooms. Of course a lot of listeners are not technically inclined and may unconsciously attribute rotten sound to the software being played, and not to the hardware through which it is being broadcast.

In the recording business, I know of at least one formerly-prestigious studio that is slowly going out of business because its top management has no conception of today's needs. Its studios are superb—by 1957 standards. Unfortunately, this is 1977, but no one upstairs seems to have noticed.

I don't know whether this sort of thing "translates" into the broadcast business. I suspect it does though. I think the average listener would recognize and appreciate an improvement in broadcast quality. But I think it is broadcast (*and* recording studio) management that needs to get this message. In either venue, the engineer is probably on salary, and is doing the best job he can under the circumstances. Okay?

If not, I didn't write this column anyway. ■



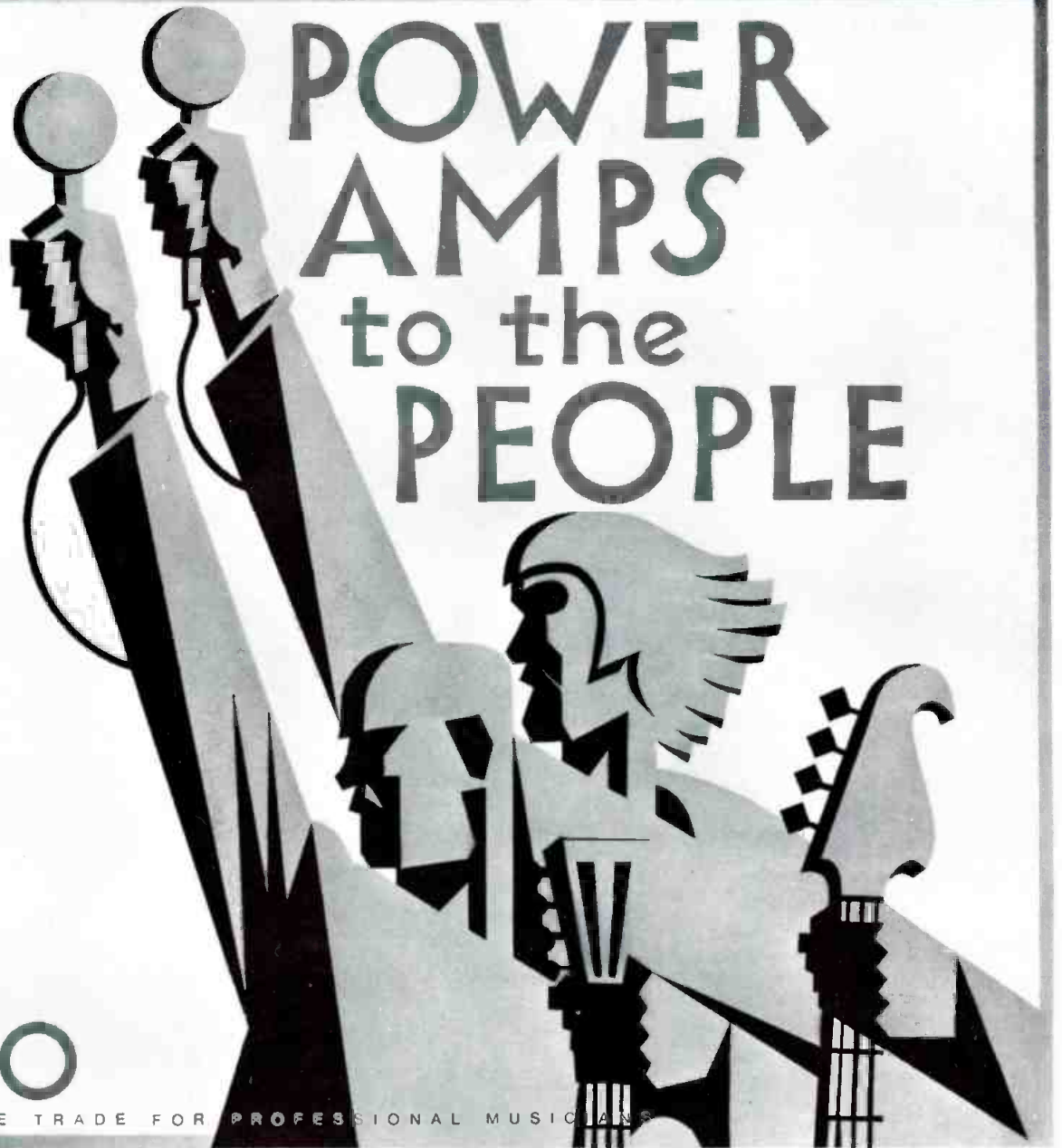

# POWER AMPS to the PEOPLE

## TAPCO

TOOLS OF THE TRADE FOR PROFESSIONAL MUSICIANS

Power amplifiers have been the stepchildren of the electronic revolution for too long. Many so-called "power amps" are nothing more than redesigned hi-fi amplifiers. Others sacrifice sound quality to attain high volume levels. Still others risk blowing out expensive speakers every time the volume is turned up.

Tapco meets the challenge with two new stereo power amplifiers. Both are designed from the ground up. Both employ Tapco's exclusive Power Sentry® to control clipping distortion and help protect expensive horn drivers. Both are designed to reproduce distortion-free sound at the volume levels demanded by today's professional musicians. And both are engineered and built by the most respected name in sound reproduction.



### CP 120

Rated at 61 watts per channel in stereo, 122 watts mono. Each output is capable of 500 watts total stage dissipation for only 61 watts of rated output power. Sophisticated protection circuitry guards against gross fault conditions without ever affecting sound quality. Power Sentry® protects against clipping distortion, and advanced-design convection cooled heat sinks keep the CP-120 running cool even at full power.

*Tapco power ratings are in accordance with the Federal Trade Commission rulings concerning power output claims.*



### CP 500 / CP 500M

Designed for full-range sound amplification, or for bi-amp setups with its counterpart, the CP-120, this fan-cooled stereo amp is rated at 255 watts per channel in stereo, 510 watts mono. Tapco's exclusive Power Sentry® protects against prolonged clipping distortion, and consequent loss of tonal quality and danger to speakers. Output protection circuitry is safe and confident. Each of the 8 output devices per channel is rated at 250 watts, providing a total output stage dissipation of 2000 watts. An optional readout package is available (CP-500M).

Send me full information and specifications on Tapco Power Amps.

Yes, I'd also like this ad reproduced on a T-shirt. I am enclosing \$3.95 for each shirt ordered.

Size:  small  medium  large  ex. large

Make checks and money orders payable to TAPCO

NAME \_\_\_\_\_

ADDRESS \_\_\_\_\_

CITY \_\_\_\_\_ STATE \_\_\_\_\_ ZIP \_\_\_\_\_

Send to: Ahmet Akimbo, Tapco, 3810 148th Avenue Northeast, Redmond, WA 98052.

Circle 50 on Reader Service Card

# Audio Tape for professionals



## REEL TO REEL TAPE

Ampex, 3M. All grades,  
On reels or hubs.

## CASSETTES, C-10—C-90,

with Agfa, Ampex, 3M Tape

## LEADER & SPLICING TAPE

## EMPTY REELS & BOXES

All widths, sizes.

— COMPETITIVE • FROM STOCK —



Recording Supply Co.

1233 Rand Road  
Des Plaines, IL 60016

Div. of  
Polyline Corp.

312/297-0955

Circle 22 on Reader Service Card

# Reel Holding Power

When you're looking for a quick-loading, highly reliable method of securing either NAB or RETMA tape reels in place, look to the VIF 1000 Lock-Down Reel Retainer.

This precision designed retainer works with 1/4" and 1/2" reels on both rack and console mounted recorders. And, the VIF 1000 has been developed to provide you with years of trouble-free service even under the roughest handling.

Price: \$13.50 each



Professional sound equipment for  
the professionals in sound.

# VIF

**INTERNATIONAL®**  
The World's Largest  
Manufacturer of Reel Retainers  
P.O. Box 1555  
Mountain View, CA 94042  
(408) 739-9740

Circle 16 on Reader Service Card

MARTIN DICKSTEIN

# db Sound With Images

• The season of the video disc conference is here again. We hope you were able to attend the Video Expo '77 convention at Madison Square Garden in New York held October 11 through 13, sponsored by Knowledge Industry Publications, and the Consumer Videotape/Videodisc Seminar at the New York Sheraton from October 25-27 run by the International Tape Association.

A third conference is the International Videodisc/Home Video Programming Conference to be held November 16-19 at the Loeb Conference Facility of New York University. The sponsor of this latter meeting is Visiondisc Corporation, New York City. The theme of this, the second annual conference, is "The Future Defined" and it will have displays of videodisc players, home video equipment, as well as offering 15 panels of experts discussing a variety of subjects.

One of the sessions will be on the videodisc and its application in education. Mr. Charles Arden, president of Visiondisc and chairman of the conference, made the suggestion that db talk with Dr. Dustin Heuston who is Chairman, World Institute For Computer Assisted Teaching, and who will be one of the members of the panel. We did, and the following are some of his comments.

"The Institute has a few major areas and one of them is the video disc. We're interested in the video disc because it has more potential for education than any other technology. In fact, it is really a culmination of the three most powerful technologies that we've ever had to harness for education. Most people have forgotten that the book is really a product of technology. But it's been very useful in education.

"The second technology is television and the movie format. It has certain critical weaknesses. The last is the computer, which we also hope to harness for education. All three have critical major weaknesses along with some awesome strengths. What the video disc does is to combine the strengths of the three technologies. It not only combines them, but it eradicates their weaknesses.

"The weakness of television is that it is a serial presentation. It does not permit the viewer to get to the data rapidly—if you want to see how the Yankees did, you sometimes have to

kill a half hour. In terms of learner productivity, that is, trying to learn, that is a disaster. The second thing it can't do is give you a trial and get a response. So you sit there passively with this thing tooling by. You can't stop it. You can't interact with it. It has awesome strengths. It has color, sound and motion, characterization, and extremely pleasurable visual effects, and we like that emotionally as viewers. But in terms of education, it's not very effective for learner productivity.

"The other technology that I mentioned is the book and the book has been very effective. It's portable, it's light. It carries information that can be replicated on printing presses, and you can get it out and distribute it. It has some weaknesses. It's not interactive, so it's sort of a passive device. And more importantly, it doesn't have color, sound, or motion—so if the student is already a poor student, the print isn't going to help, and it's not emotionally as exciting or fulfilling. It's good for the bright ones, but not as good for the people who really need it.

"The third area is the computer, and the computer excels in some areas the others don't. It's perfect for giving trials with immediate response. The microprocessor now can play a million instructions a second. It costs just a few dollars, and that means that we're going to be able shortly to give students questions, followed by the student responding, followed by a response to the student's response. Most people don't realize that you must have a lot of trials to assimilate the information in an area. The computer has this incredible ability to provide trial with response, and it has the random access ability. Immediately, you can go to data anywhere.

"So, the three technologies all have strengths and weaknesses. The video disc will put it all together so that we'll be able to have random access ability, we'll be able to freeze any frame and hold it. We'll be able to have the student give a trial into a microprocessor with that and we'll get immediate response with color, sound, and motion. There's no greater potential in education than the video disc, now or in the future.

"The computer has terrific interactivity, but its presentation format is dismal. All it can do is to show you some print, and also it can't have any

audio. The President of my Institution, Dr. Victor Bunderson, completed a \$6,000,000 project for the government designing the first interactive color television work with a computer, and there was some brilliant work done, but what he found was that he couldn't store enough audio digitally on discs to have very much audio to interact with. He has on his system 6 IBM 2314-type discs. To create a data base of interactive audio response as large as a single video disc, his system would have to carry 270 discs on it if you were going to store it digitally. So that's the kind of price trade-off that this awesome new instrument is going to give us.

"We'll use it in all its components. We're taking it slow, now. We're going step by step. We're doing the first educational video disc project ever done with McGraw-Hill right now under Alan Kellock. We're finding some astonishing things as we're working on it. The first step, we'll be using discs of the consumer home model. In this, what we're doing is taking a movie that McGraw-Hill has had as a best seller. We've provided the subject matter to experts in biology. They're analyzing its subject matter content. They've divided it into six or seven instructional segments, and we're inserting still frames which will have an instructional pattern in them. What will happen is there will be some instruction in the film just as there is now, followed by an automatic frame stop which will be coded, and it'll suddenly stop on the frame. This will begin the instructional sequence where the student will be asked questions, and then they can branch by addressing different frame numbers. It'll all be done manually in these earlier versions, but this will all be computerized in the future.

"The marvelous aspect of the video disc is that it can number those 54,000 frames. So, really what a video disc is is 54,000 individual color television frames. And you can view that in terms of simply a data base of 54,000 individual frames. If I chose to run it on television, it takes 30 a second to give you a motion effect, and you multiply that out by half an hour and you come to the figure 54,000. If I choose to pull ten seconds away from that, I now have 300 still frames that I can insert. It gives you basically the power to put in graphics and textural material of enormous quantity in still frame segments to back up the picture you've just seen. And the thing that's delighted our team and caused an enormous amount of internal emotion and excitement on the project is the recog-

nition that we're able to add enormous dimensions of knowledge to a medium that was very powerful to look at, where it's slick, exciting emotion, but really did not have the power to teach you. . . .

"It turns out you have these two levels, now. You have this very high exciting visual level with sound and music, but underneath you have this very powerful analytic material being added, which is much closer to a book. Then you're going to add the computer aspect which is the ability to ask a question and have the student respond. After that, the video disc automatically goes to that section of instruction, which tells the student what he did or did not do. It will all be done automatically.

"Now where this becomes impressive is that you've suddenly got millions of homes to which this can go. They already have the color television screen. All they need is a player. And, so, overnight you have the ability to start bringing education to all kinds of people—you're at the threshold of an extraordinary revolution right now. It's going to take ten to twenty years to master it. It's all too new. There are too many lessons to learn. What WICAT is trying to do is to take people in slowly and systematically, step by step, and they'll probe and learn, and probe and learn, and so on. . . .

#### TAPE

"Handling tape is like handling wet spaghetti and it takes a good deal of sophisticated machinery to do it. Therefore, it's always going to weigh more, and cost more, be more mechanical, and break down easier than the video disc player. Secondly, the video disc will have less inherent cost for the physical equipment. It will also have higher reliability. The video disc itself will not wear out as tape does because it's being read by a laser. You can have fingerprints, minor scratches, and dust on the surface and it doesn't affect it because they've designed the light stylus to be out of focus as it goes by the surface of the record. It'll be much easier to handle than tape in that sense and it's a better investment.

"The raw material for the video disc looks like it's probably going to cost between 20 and 50 cents to really make one in quantity, whereas the tape for a video recorder has to cost a great deal more than that just for the raw tape."

"Although the video disc will have two channels of audio, it will not have the ability to accept the student's response and turn around and play it

## Turn on a better idea

FULL  
EXPANSION

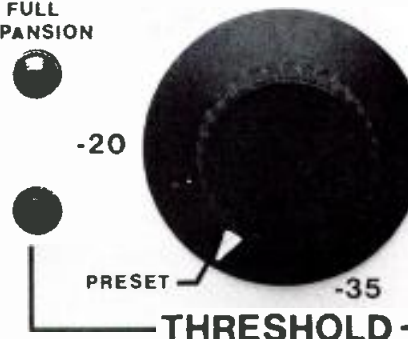

Program-controlled filter suppresses residual background noise in audio reproduction systems. Selectable low frequency, high frequency, or wideband suppression modes.

# Inovonics' DYNEX Noise Suppressor

Model 241 - \$280

**Inovonics Inc.**  
503-B Vandell Way  
Campbell, CA 95008  
(408) 374-8300



Hear a demonstration at the AES demo room 10W.

**TDK AMPEX**  
Minimum Order 12 Tapes

## Blank Tapes

at wholesale prices!

CASSETTE TAPES		DBO
Maxell LN C-60	1:12	
Maxell LN C-90	1:19	
Maxell LN C-120	2:09	
Maxell UDC-60	1:14	
Maxell UDC-90	2:55	
Maxell UDC-120	3:45	
Maxell UDXL 1 or 2 C-60	2:22	
Maxell UDXL 1 or 2 C-90	3:12	
Memorex C-90 3pk	4 99 for 3	
Scotch C-90 3pk	3 99 for 3	
Scotch Master III C-90	3 29	
TDK D C-60	1 14	
TDK D C-90	1 56	
TDK D C-120	1 98	
TDK D C-180 (180 minutes)	2 88	
TDK AD C-60	1 67	
TDK AD C-90	2 40	
TDK AD C-120	3 30	
TDK SA C-60	1 98	
TDK SA C-90	2 88	
REEL-TO-REEL		
Maxell UDXL 35-90B 1800 ft	5 46	
Maxell UD50-60 1200 ft	3 87	
Maxell UD35-90 1800 ft	4 50	
Maxell UD35-180 3600 ft 10 1/2"	12 00	
Scotch 206 1200 ft	3 99	
Scotch 207 1800 ft	4 49	
Scotch 212 1800 ft	3 59	
8 TRACK		
Maxell LN 8T 90 min	1 79	
Memorex 2 pk 90 min	3 59 for 2	
Scotch 2 pk 90 min	3 59 for 2	

**J & R Music World**  
33 Park Row N.Y.C. 10038  
[212] 732-8600

MAIL ORDERS: For shipment within 48 hours send money order or certified check. Two weeks delay on personal checks. Please add \$2.50 per order for shipping & handling. N.Y.S. Residents add tax. NO C.D.D.'s  
ALL TAPES 100% GUARANTEED

Write for prices on other tapes

October 1977 dB

33

# maxell

## FOR REEL QUALITY



LOGGING LENGTHS AVAILABLE

### ASK US!



**AUDIO SALES LTD.**

FULL LINE DISTRIBUTOR  
FOR AUDIO RECORDING

1370 Avenue of the Americas  
New York N.Y. 10019 (212) 581-6950

Circle 53 on Reader Service Card

**616 - 452 - 1596**

**Your Direct Line To  
PROFESSIONAL  
AUDIO  
EQUIPMENT**

**We represent, stock, sell,  
and service only the best**

... such names as ...

- Audiotronics
- Ampex
- Beyer
- Cetec
- Crown
- DBX
- Eddcor
- Electro-Voice
- Editall
- Fidelipac
- LPB
- Marti
- Micro-Track
- Nagra
- Neumann
- Nortronics
- Pulse Dynamics
- Ramko
- Revox
- Russco
- Scully
- Sennheiser
- Shure
- Sony
- Soundcraftsman
- Spotmaster
- Switchcraft
- TEAC
- Tascam
- UREI



**Audio Distributors, Inc.**  
2342 S. Division Avenue  
Grand Rapids, Mich. 49507

**Trades Welcome**  
**Anything That Doesn't Eat**  
**Lease Plans Available**

Circle 46 on Reader Service Card

out, but the two-channel capacity has other possibilities. One of the fascinating educational opportunities with the video disc will be offering say, a version in English and a version in Spanish and you can play either one. Or, if you like, the disc can be recorded in just one language, in stereo. In other words, you can use those two channels any way you want."

### FLEXIBLE LEVELS

"A lot of material is, frankly, level-blind from an educational level. We'll be able to record a lot of the disc's material for no particular level, just recording it per se for whatever it is. Then we'll insert a choice of different audio, to explain the video at different levels, which is a fascinating concept. Conceivably, a disc, instead of having two languages . . . can describe what you're looking at for elementary school students. The same disc could have alternate audio for advanced college students with mathematical descriptions incorporated."

"I think that one of the second generation features of the video disc will be the addition of sound in a freeze-frame mode, so that, let's say I wanted to design a video disc with some normal audio visual motion and then go into a freeze-frame individual frame but would give up every other track. Remember there are 54,000 tracks. In giving up one of those tracks next to a freeze frame—in ten seconds of that half hour, instead of having 300 freeze frames I would choose during the ten second take-away to use 150 freeze frames and 150 sound tracks. I can compress ten seconds of sound on one of those tracks, so that every time I play a freeze frame, a voice can talk for 10 seconds. I'll be adding a considerable amount of sound to the disc. If I make every other track a sound one and reserve the other half for playing or for freeze-frame, I would then have 75 hours of verbal explanation available. That's so much potential that I don't really know what's going to happen when we go to put all this together. It isn't quite ready yet. It will be another generation out, but we're going to be exhausted learning how to use this."

### MEMORY

"Either the video disc itself in its early grooves will carry the program in it, which it will dump to the computer memory—or, in a keyboard there will be a read-only-memory which you put in. This will drive a video disc the way you want it to be done. There are two competing technologies that have not been firmed up. It would appear at this point that

MCA likes the concept of AROM, a read-only-memory which is plugged into the keyboard path. The disc would remain relatively neutral and you would put on a series of possible instruction sequence steps. From Philips' early commentary, it sounds as though they might prefer to put the instructions for the disc on a few of the tracks so that it would be included as part of the disc proper. In that case the keyboard will simply be a neutral element that would drive the disc according to the program which had been dumped in from the disc."

"Anyone who is involved in education just really gets excited if he understands the philosophical underpinning of the process. We're about to have an absolute breakthrough. It'll take 20 years, but at the end of that time, we'll have some extraordinary change because we're going to combine the book, the television movie, and the computer altogether. That is impressive."

### THE MCGRAW-HILL PROJECT

In talking about the video disc in education, Dr. Heuston mentioned the McGraw-Hill project for developing the first educational video disc. He suggested talking with Mr. Alan Kellock, Vice President, McGraw-Hill Book Company. Mr. Kellock was kind enough to let us excerpt from a talk he gave in June of this year at a conference in California, sponsored by the Institute For Graphic Communication, on *Applications of Video-disc and Video-disc Technology*.

The talk, with slides, presented a well developed study of the present traditional methods of education where the students go to school, take courses, take exams, and so on. However, the statistics of recent surveys, have shown that the methods of education have changed and so has the composition of the age groups studying. "In the 6-year period, 1969 through 1975, the number of participants in adult education rose almost 31 per cent while the number of regular full-time students in high school and college rose only 4 per cent. By May of 1975, when the latest Current Population Survey was made by the Census Bureau, the total enrollment of full-time students age 17 and older in high school and college was only 2/3 of the total of participants in adult education—11 million compared to 17 million."

Mr. Kellock discussed the reasons for the changes, for example, the tremendous increase in such out-of-school education as correspondence courses. "Up to this point we have focused our attention on the development and cur-

rent status of independent study within the domain of higher education. Our objective has been to set the stage for us to establish some conjectures about the possible future applications of videodisc technology in independent study."

"I will assume the existence and availability of an optical videodisc system which will provide a student terminal with a high degree of versatility. It will have the basic capability by means of a videodisc player and t.v. receiver to serve as an all-in-one display mode for several different means of audio-visual presentation, such as sound motion pictures, videotapes, transparencies, slides, and silent filmstrips. It will also have the consumer mode videodisc player's standard features such as up to 79 automatic stops in a 30-minute motion picture, the random manual freeze frame, the accessible visual frame index number display from frame numbers 0 to 54,000, the single frame forward and reverse, the motion control in forward and reverse adjustable from normal speed down to four seconds per frame, the normal speed reverse as well as forward, two audio tracks, and fast speed forward and reverse."

The slides shown by Mr. Kellock to illustrate his presentation included diagrams of the control keys, a schematic of the connections between the console and the videodisc machine with a t.v. receiver, and a picture of the console keyboard. There were three parts to the console. The left side provided control for "Cursor Motion", (forward, reverse, stop, etc.) the center "Alpha-Numeric" section allowed the student to enter at any frame for still or motion presentation and permitted "branching" from one sequence to another. On the right side, the student could select his own learning approach and tactics. For example, the key marked MAP provided a look at the overview plan of study. The OBJ key showed a statement of the learning objective. RULE provided access to the lecture or explanation of the segment content. REPEAT allowed for a replay of the previous material. Keys marked EASY or HARD provided levels of explanation. The EX key gave examples of the subject matter, and these could be made EASY or HARD also. A key marked HELP gave another approach to the subject material if the student felt the need for it. Recommendations for learning strategy could be summoned with an ADVISE key, and the PRAC key offered a chance for the student to practice his material. Testing would also be possible, and options would be provided for either backup and repeat

or branching to another segment of the lesson, if desired.

Mr. Kellock concluded "... we know that today there are about 6½ million students taking some form of part-time post-secondary education at colleges, universities, and technical institutions. Although only a relatively small percentage of those 6½ million are doing their matriculation entirely or mainly at home, perhaps many more would do so if a program like this became available for interactive independent study. This question can beg little more than a kind of 'educated' speculation at this moment in

time, but the potential implications and possibilities of the videodisc system for individualized, interactive instruction do provide interesting parameters for that speculation."

Our sincere thanks to both these gentlemen for allowing us to share some of their thoughts on the future of the videodisc in the field of education. Mr. Kellock will be the chairman of a panel of which Dr. Heuston will be a member at the forthcoming International Videodisc/Home Video Programming Conference. It will be most interesting, indeed. Try to be there if you can. ■

## Radiometer Electronics Introduces . . .

# the specific generator



and

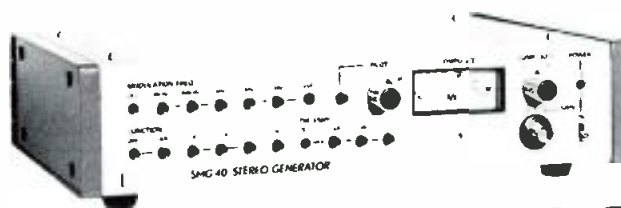

# the stereo generator

**Spectacular quality FM and AM signal services at your fingertips.**

An unsurpassed combination for AM, FM, FM Stereo receiver testing and design in R&D, Production, QC, and Service activities.

We believe this combination provides the cleanest FM Stereo with the best separation, lowest distortion and greatest flexibility available today. These are just the highlights . . . like to know more? Contact us for additional information or a demonstration.

### RE 101 — RF GENERATOR . . .

Specifically designed for the radio industry.

- Digital display of carrier frequency in FM and AM specific ranges of 86 MHz to 130 MHz and 150 kHz to 30 MHz plus 10.7 MHz.
- Internal or external FM and AM modulation.
- Exceptionally low distortion; 0.05% FM and 0.3% AM.
- Low leakage RF output; continuously variable 0.1µV to 1 V rms.
- Built-in Sweep capabilities.

### SMG 40 — STEREO GENERATOR . . .

The ultimate stereo modulation source.

- Full function capability; L&R, L=R, L=-R, L, R.
- L-R Separation; better than 65 dB.
- Low Distortion; less than 0.03%.
- Residual 38 kHz; less than 0.06%.
- Five built-in modulation frequencies.

**THE LONDON COMPANY**

U.S. Representative for

**re** Radiometer Electronics

811 Sharon Drive • Cleveland, Ohio 44145 • Telephone (216) 871-8900

Circle 30 on Reader Service Card

# db New Products & Services

## DIGITAL RECORDING SYSTEM

● Useful in identifying analog recording problems, especially those originating at the signal-to-tape interfaces, the digital recording system converts audio to its digital equivalent by means of a 16-bit A/D converter. This is recorded serially on tape as numerical information; however, since the signal-to-tape interface affects only the fine structure digit-carrying signal and not its numerical content, no audio degradation occurs, while the integrity of the numerically encoded audio is strictly maintained. During playback, the numerical information is read and stored in a finite memory. The original audio signal is then reconstructed by a reverse 16-bit D/A converter under crystal oscillator control. The manufacturer, who claims that the device makes noise reduction unnecessary, reports the thd distortion and noise to be better than  $-85$  dB and intermodulation distortion better than  $-80$  dB. *Mfr: Soundstream, Inc.*

*Circle 60 on Reader Service Card*



## A/V SYNCHRONIZER

● Microprocessor-based MQS-100 series synchronizing system can cue and synchronize any three mag tape transports, including video, audio, and mag film simultaneously. The SMPTE/EBU edit code, used for the indexing of the tapes, need not be identical. Tapes with drop-frame and non drop-frame can be intermixed. Synchronizing actions include high speed search and cue, "chase" mode, synchronized playback, fast and slow re-synchronization and roll-back with automatic re-synchronization. One button causes all transports to roll back, start forward, and synchronize automatically. Individual time code readings or readings for all tapes simultaneously can be viewed during operation; a plus or minus offset of any selected time increment can be preset for each slave transport.

*Mfr: Ampex Audio-Video Systems Div. (EECO)*

*Circle 61 on Reader Service Card*

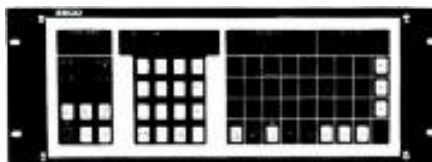

# New Literature

## HISTORY OF AUDIO

"The Evolution of Recordings from Cylinder to Video Disc" is offered free of charge. Mfr: Audio Engineering Society, 60 E. 42nd St., New York, N.Y. 10017. Membership Services.

## NETWORK DESIGN

A brochure describes a new book, ACTIVE NETWORK DESIGN by C. S. Lindquist. Mfr: Steward & Sons, P.O. Box 15282, Long Beach, Ca. 90815.

## PROFESSIONAL TAPE COMPONENTS

A new line of tape components and their specifications are included in this catalog. Mfr: Form PA 2230, Professional Audio Dept., Telex Communications, Inc., 9600 Aldrich Ave. S., Minneapolis, Minn. 55420.

## CONSOLES

Full-color literature describes broadcast consoles. Mfr: Cetec Broadcast Group, 75 Castilian Dr., Goleta, Ca. 93017.

## TRANSISTORS

High energy epi base power transistors and Darlingtons are featured in a 6-page brochure. Mfr.: International Rectifier, Semiconductor Div., 233 Kansas St., El Segundo, Ca. 90245.

## MINICOMPUTER ACCESSORIES

CRT accessories, tape and diskette mailers are just two of the items offered in a 40-page catalog. Mfr: Minicomputer Accessories, 1015 Corporation Way, P.O. Box 10056, Palo Alto, Ca. 94303.

## HIGH SPEED SWITCHING

A 10-page report "Methods for Utilizing High-Speed Switching Transistors in High Energy Switching Environments, replete with many diagrams is available. Mfr: General Semiconductor Industries, Inc., 2001 W. 10th Pl., Tempe, Az. 85281.

## COAXIAL CABLE

Information such as applications ranging from data transmission to fiber optics for a.m., f.m., and t.v. modulators and demodulators is covered in regularly issued Categram. Mfr: Catel, 1400-D Stierlin Rd., Mountain View, Ca. 94043.

# Introducing the new TDK testing machines.

At TDK, we know that your test cassette is a vital element of your laboratory or service procedure. So when we created a series of test tapes, we approached them as integral components, with both tape and housing engineered as precisely as your test instruments. You'd expect that from the makers of TDK SA, the high bias reference standard for many manufacturers' cassette decks.

TDK test cassettes don't jam and they're dropout-free. They're built to last under unceasing use. If you're a store service manager, assembly line quality control inspector, or highly discerning audiophile, you need that kind of precision and reliability. To make absolutely sure you get it,

we custom quality-control each and every one. No matter what data you need, TDK has a test cassette to help you find it out: bias/EQ alignment; playback level calibration; Dolby calibration; head azimuth alignment; wow and flutter and tape speed and 11, five and three-point frequency characteristics checks.

Check out the complete line of TDK test cassettes by writing, or calling (516) 746-0880. When you do, find out about our bulk duplication cassettes, bulk duplication pancake tape, audio visual, leaderless, data and endless cassettes, too. You'll find that the same TDK quality and reliability that goes into our test tapes applies all the way down the line.



**TDK**

World leader in recording tape technology.

TDK Electronics Corp., 755 Eastgate Boulevard, Garden City, New York 11530. In Canada, contact Superior Electronics Industries, Ltd.

Circle 20 on Reader Service Card  
www.americanradiohistory.com

### MULTIPLE WIRING

● This many-headed cable, appropriately named Medusa, is available in eight standard setups for p.a. or multiple recording needs. The setups range from 50-foot cable, 6 mics in, with 3 sends to 100-foot cable, 24 mics in, with 3 sends. The manufacturer will custom-design cable configurations to fit individual needs. Stage boxes are also available in basic sizes and connector configurations, with optional possibilities. Standard inputs are XLR female, but others may be specified; phone jacks can be ordered in 1/4 in. phone jacks or XLR male configurations. Other options include impedance matching and splitter/transformers.

*Mfr: Whirlwind Music*

*Circle 62 on Reader Service Card*



### 8-BUS CONSOLE

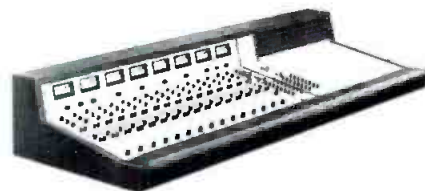

● Each input module on QM-168 16-in console has solo, mute, two independent echo sends, and two independent cue sends, six frequencies for eq. on three knobs with an equalizer in/out switch included and a mic/line switch with 15 dB padding on the mic. Plastic faders and panning connect to the 8 busses. The stereo monitor has pushbutton selection of bus, line, or playback, with a separate control for additional operation of cue masters and solo. The talkback slates to the 8 busses, two cue busses, and to the studio monitor feed. Meters and bus master controls are included on each of the bus outputs with an additional master for busses one and two.

*Mfr: Quantum Audio Labs, Inc.*

*Price: \$5,900.*

*Circle 64 on Reader Service Card*

### EVALUATOR PROBE

● Designed to operate with a vtm or oscilloscope this a.c. magnetic field evaluator probe has a sensitivity to 60 millivolts per gauss. Either axial or transverse pickup coil positions are available. The shielded banana plugs on 3/4 in. centers fit most input jacks. Suggested application is measurement of the disturbing field intensity in gauss as a gauge of magnetic shielding material.

*Mfr: Perfection Mica Co.*

*Circle 63 on Reader Service Card*



# Peak Program Meters to BBC Standards

These are not "souped up" vu meters!

Peak Program Meters that fully comply with the BBC standard for system ballistics and accuracy are now available from a U.S. manufacturer. Full differential, high impedance input. They can operate from either +24 or ±15 volts. A high quality WESTON meter movement is standard. Order your 3½ inch PPM today at \$198.00, freight prepaid. Charge it with VISA, BANKAMERICARD or MASTERCARD. Immediate delivery.

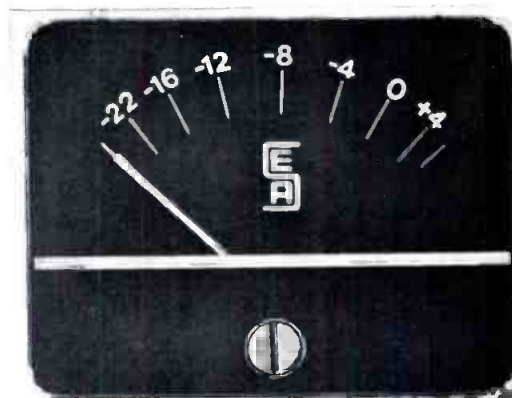

ERIC SMALL & ASSOCIATES  
680 Beach Street, Suite 365  
San Francisco, Calif. 94109  
Phone (415) 441-0666

*Circle 28 on Reader Service Card*

[www.americanradiohistory.com](http://www.americanradiohistory.com)



# Dolby B-Type Processing

*Dolby B-type encoding reduces the distortions of stereo f.m. pre-emphasis without losing compatibility with conventional systems.*

**H**IGH QUALITY f.m. transmission was conceived by E. H. Armstrong in 1933 and first demonstrated publicly in November, 1935.<sup>1</sup> Apart from a few minor changes, such as the introduction of pre- and de-emphasis (1940) and stereophonic transmission (1961), the f.m. system has been unchanged.

During the 1950's, the quality of f.m. transmission and reception was excellent, far surpassing other available transmission media, including the disc. Ironically, it was the introduction of the two changes noted above, along with some unfortunate commercial practices, which began the degradation of f.m. signal transmission. The purpose of this article is to examine the technical reasons for this degradation and to show how the Dolby B-type signal encoding and decoding process has helped to recover some of the lost signal quality.

## PRE- AND DE-EMPHASIS

The concept of raising the transmitter drive at high frequencies and using a complementary loss network in the receiver has certain superficial attractions for providing an improved signal-to-noise ratio for the transmitter-receiver link. The noise spectrum of an f.m. system is triangular, so that the noise character is predominately high frequency in content. Thus, introducing pre- and de-emphasis makes a very significant improvement in the perceived signal-to-noise ratio; calculation for wideband

measurement (for example,<sup>2</sup>) gives an improvement of 11 dB for a 75  $\mu$ sec system, and 7 dB for 50  $\mu$ sec. However, full advantage can be realized only if the program energy content at high frequencies follows substantially the same shape as a 50 (or 75)  $\mu$ sec de-emphasis curve. While this was a reasonable expectation in the late 40's and early 50's, improvements in microphones, tape recorders, techniques of close miking and multitrack recording, as well as changing musical styles, have resulted in an energy content at such high frequencies it is no longer possible to take full advantage of pre-emphasis techniques. The 75  $\mu$ sec curve produces a boost of about 3 dB at 2 kHz and 14 dB at 10 kHz (the figures for 50  $\mu$ sec are 3 dB at 3 kHz and 10 dB at 10 kHz). Even in 1956, these figures were found to be excessive;<sup>3</sup> indeed only 3 dB of the theoretical 7 dB pre-emphasis improvement in the 50  $\mu$ sec system could be used. In 1977, the improvement is even less.

## STEREOPHONIC TRANSMISSIONS

Many systems have been evaluated for providing two separate audio channels using a single transmitter. The system chosen in the U.S.A. (1960) was the Zenith-G.E. (pilot-tone) system, adopted subsequently by many other countries. In common with all systems considered, the Zenith-G.E. system imposes a signal-to-noise ratio degradation for stereo listeners. For the 75  $\mu$ sec pre-emphasis transmission standard, this is 23 dB; for 50  $\mu$ sec, 21.5 dB.<sup>2</sup> This is a substantial loss and cannot be recovered easily, meaning inevitably that many listeners will experience unsatisfactory reception in stereo while being adequately served in mono.

## CONVENTIONAL SOLUTIONS

Faced with the high frequency overmodulation problem, the broadcaster has two choices. First, he can reduce

*D. P. Robinson is with Dolby Laboratories. This article was presented as a paper at the 10th International Symposium and Technical Exhibition, Montreux, June, 1977*

his average modulation level so that the majority of the high frequency energy is passed through the transmitter without clipping. Unfortunately, this reduces the average loudness of the program, which in turn worsens the signal-to-noise ratio. There are few stations which can be so wholeheartedly concerned about high frequency signal integrity to do this, particularly in countries with commercial broadcasting.

The alternative approach is to use a variety of signal processing equipment, either to statically or dynamically reduce the high frequency content of the program sent to the transmitter in order to allow a high average level to be maintained. Whether or not these devices are often obtrusively audible varies from device to device and how they are used by the broadcaster; all are detectable from time to time. Apart from the exchange of one signal degradation for another, the introduction of these non-complementary signal processors forever precludes the possibility of the listener recreating at home the signal sent out from the broadcast studio. With the increasing sales of and interest in high fidelity equipment, this is not a welcome state of affairs. Perhaps it is not altogether coincidental that in those countries which are subject to commercial broadcasting pressures, f.m. radio is more often used for background material, with serious listening coming from disc and pre-recorded tape.

A third proposal is to alter the time constant of the pre-emphasis network. Such proposals have been put forward from time to time, including one ingenious suggestion<sup>4</sup> that the time constant should be changed by a controlled amount year by year, with a reduction to zero after a period of ten years. Unfortunately, modern receivers have sufficient life expectancy to enable them to be used for the reception of transmissions with a new pre-emphasis for many years; bearing in mind the 14 dB loss at 10 kHz that would result (75  $\mu$ sec pre-emphasis system), it is easy to see that this would not be a practical solution.

#### USE OF DOLBY B-TYPE PROCESSING

The Dolby B-Type noise reduction system has been used for many years in cassette recorders and in the manufacture of pre-recorded tapes. The system is well documented for this application.<sup>5</sup> In 1971 it was applied to f.m. transmissions.<sup>6</sup>

At that time it appeared that the predominant contribution would be simply to help correct the signal-to-noise

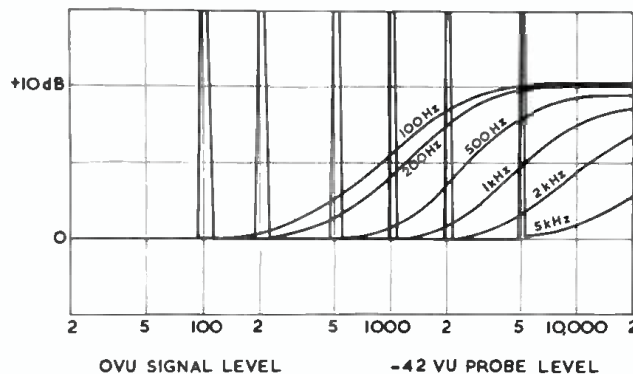

Figure 2. The encode processor characteristics in the presence of high level program (illustrated by tones of 100 Hz to 5 kHz).

ratio degradation brought about by the introduction of stereo. However, it soon became clear that the pre-emphasis characteristic was limiting and would continue to limit the development of f.m. as a high fidelity medium. A combination of changing the time constant to 25  $\mu$ sec with the simultaneous introduction of B-type encoding was proposed.<sup>7</sup> The two published papers<sup>6,7</sup> discuss the theory and practicalities of this use of the Dolby B-type system in detail; it is, however, appropriate to outline the basic principles here.

The block diagram of the B-Type system is shown in FIGURE 1. Low level high frequencies are boosted (by 10 dB above 5 kHz); in the decode mode an equal and opposite cut is applied, restoring the signal to its original form but attenuating all low-level noise introduced between encoder and decoder. At high levels the signal is essentially unchanged, so that no special precautions are necessary when using the technique with pre-emphasized systems or slow speed magnetic tape. While the symmetry is apparent from the block diagram, it can be shown mathematically (as well as by experiment) that if there is no loss in signal between encoder and decoder, the decoded output will be an exact replica of the input to the system. FIGURE 2 shows the low level frequency response of the encode processor under high-level signal conditions; that is, the operation of the encoder and program conditions. (This composite graph is generated by plotting the response of the encoder to a variable frequency probe tone at very low level (-42 vu, corresponding to the "0" line on the graph) while simultaneously injecting a discrete single frequency high level (0 vu) tone. The probe tone is measured with a tracking voltmeter synchronized to the probe tone frequency; the frequency of the high level tone is changed after each sweep of the probe tone to build up the composite graph.) The sliding band action (a fundamental contributor to the effectiveness of the Dolby B-type system) is plain to see.

To this basic characteristic is added a 50-25  $\mu$ sec conversion network; the resulting signal passes to a standard unchanged 50  $\mu$ sec transmitter. The response of the network is shown in FIGURE 3; the characteristics at any level are therefore the addition of FIGURES 2 and 3. The characteristics under actual signal conditions are obviously difficult to display graphically, but aurally are much less severe than might be supposed.

The improvement to the overall performance of the complete f.m. link can be seen in FIGURE 4. The top curve shows the improvement in the maximum high frequency output when the pre-emphasis time constant is changed

Figure 1. A block diagram of a Dolby B-type noise reduction system.

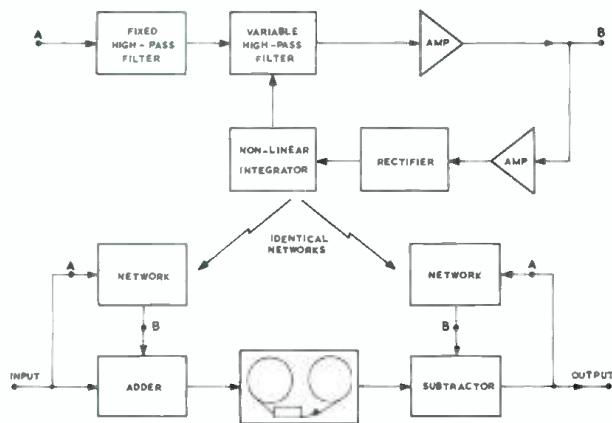

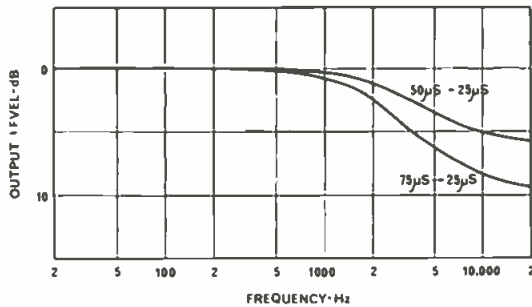

Figure 3. The response of pre-emphasis changing networks.

to 25  $\mu$ sec from 50  $\mu$ sec; the lower curve shows the noise reduction effect when the B-Type system is added. Thus the increase in dynamic range available is the sum of the differences between conventional f.m. and Dolby f.m. for both graphs.

The top curve also represents the improvement in undistorted high frequency output which is available to listeners with decoders; the bottom curve shows the added noise reduction benefits available to such listeners.

#### COMPATIBILITY WITH EXISTING RECEIVERS

If all receivers could be equipped economically overnight with Dolby B-type decoders, most broadcasters would have no doubts about the introduction of the system. Since this is an impossibility, one of the most important questions to be answered by broadcasters is how the program sounds when received on conventional equipment. It is no surprise that finding the answers to this question has occupied most of the evaluation of the B-Type system by broadcasters throughout the world. While giving useful information, it is not sufficient to perform only studio A-B tests. This will produce some programs in which there are significant differences between the two signals. These differences are slight accentuations or reductions in parts of the frequency spectrum which sound similar to balance changes. However, there are not waveform distortions or overall static frequency response errors which are detectable readily without A-B switching. Any differences are unlikely to be detected in a home environment. An analogy is the reception of color television on a monochrome receiver. There are technical areas of incompatibility (e.g. dot structure from the color subcarrier) and artistic areas (loss of a true gray scale and lack of separation between certain color shades) which are easily discernible by immediate comparison between the monochrome set and a color receiver; yet without such comparisons the transmissions are perfectly acceptable.

In the Dolby B-Type/25  $\mu$ sec situation, the consumer does not have the ability to make a true A-B comparison (since he has available only the encoded/25  $\mu$ sec signal). The tests, therefore, have to be conducted either by full engineering experiments of transmitting sequentially with and without the system in action (by implication, out of regular broadcasting hours and therefore to a very small and perhaps biased audience) or by transmission of only the encoded/25  $\mu$ sec signal with careful monitoring of listeners' letters. Ideally in this last case there should be no announcement, or at least an unannounced period for control purposes. Most authorities have chosen to transmit unannounced in normal broadcasting hours.

The first country to consider Dolby B-Type encoding with 25  $\mu$ sec pre-emphasis was the U.S.A. After many

YOUR "FISH SCALE" WAS DESIGNED  
TO WEIGH FISH!

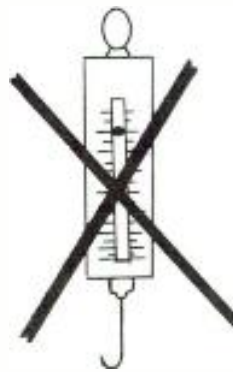

The Tentel tape tension gage is designed to diagnose problems in your magnetic tape equipment. Throw away your fish scales (or put them in your tackle box where they belong). The TENTELOMETER will measure tape tension while your transport is in operation, so you can "see" how your transport is handling your tape . . . smooth, proper tension for quality recording? or oscillating high or low tensions causing pitch problems, wow and flutter?

"See" what your heads "See" and HEAR the difference.

Tentel  
50 Curtner Avenue

(408) 377-6588  
Campbell CA 95008

Circle 32 on Reader Service Card



## B & K Two-day Regional SEMINAR

**NEW Techniques and Instrumentation  
for Electroacoustic Measurements  
on Audio Equipment**

Oct. 18 and 19  
Oct. 25 and 26  
Oct. 31 and Nov. 1  
Nov. 10 and 11  
Nov. 14 and 15  
Nov. 17 and 18

West Caldwell, NJ  
Chicago, IL  
Boston, MA  
Los Angeles, CA  
Denver, CO  
Seattle, WA

An advanced seminar designed to develop and expand the concepts, techniques and practical implementations of Electroacoustic Measurements on Audio Equipment.

The seminar will be composed of an overview of the more familiar measurements such as frequency and phase response, distortion, directional characteristics, impulse response, etc. coupled with in-depth discussions of not-so-familiar techniques and subjects such as: Multidimensional audio, 3-dimensional acoustic measurements using gating techniques, swept distortion measurements, etc.

The fee for the two days is \$60 which includes all course materials and lunches. Call or write today for complete registration information: Ms. Julie Pelz, 5111 West 164th St., Cleveland, OH 44142, (216) 267-4800.

**B&K Instruments, Inc.**  
Brüel & Kjær Precision Instruments



Circle 29 on Reader Service Card

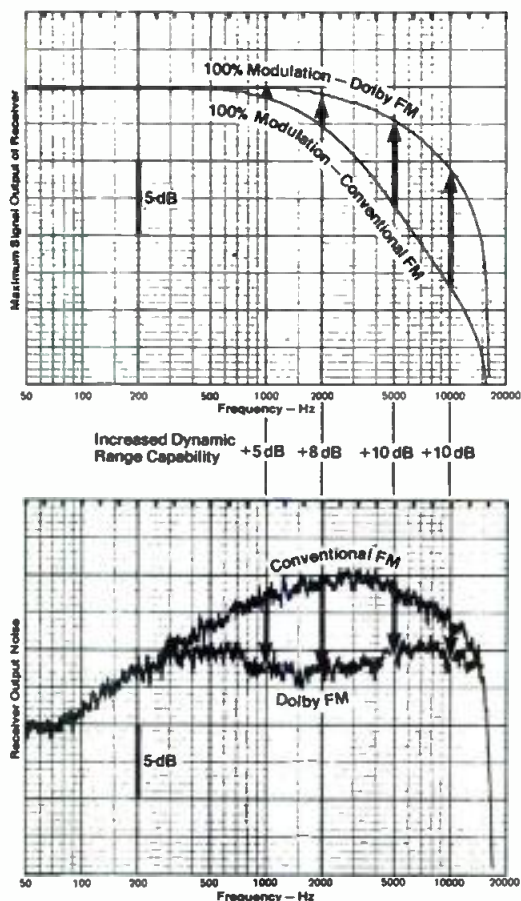

Figure 4. The overall improvement due to Dolby FM/25  $\mu$ sec system.

listening tests, the FCC gave approval for its use.<sup>8</sup> To date, there are about 180 stations in the United States which have the necessary equipment to encode their programs. There have been very many letters from listeners in support of this move, and only a very few from people who have complaints. Canada also approved the system in October, 1975 with some 12 stations on the air. Since that time, Brazil has allowed the use of the technique (13 stations), as has Mexico.

It might be expected that the level of interest would be higher in North and South America (where a 75  $\mu$ sec pre-emphasis is used) than in Europe and Japan, and indeed this is the case. Nevertheless, a significant number of tests have been conducted in 50  $\mu$ sec countries, with the major ones occurring in Germany and England. To date, one country (Luxembourg) is using the system regularly. Tests started in Germany in 1974 and have involved most of the major broadcast authorities and the IRT in Hamburg and Munich. Unannounced tests were made in all cases.

The first test conducted by Norddeutscher Rundfunk used 50  $\mu$ sec Dolby encoding; significantly, this provoked some unfavorable listener reactions. On moving to the standard 25  $\mu$ sec pre-emphasis, no further listener reactions were received through a one month period of classical programming followed by a further month of popular music transmissions. All other tests elsewhere in Germany were performed with 25  $\mu$ sec pre-emphasis and only a handful of letters were received, equally divided for and against, for a total transmission period of close to one year. German stations transmit with conservative levels in order to allow close channel spacing. In parts of the country where neighboring stations are on adjacent chan-



Figure 5. A typical consumer product.

nels there is probably no possibility of increasing deviation; however, where this is not the case, this same conservatism would allow an increased average deviation when 25  $\mu$ sec pre-emphasis is used. The conclusion of the IRT and the broadcasters was that the transmissions were indeed acceptably compatible.<sup>9</sup>

An interesting test was carried out by Dinsel<sup>10</sup> in connection with the television broadcasting sound channels. The problem of noise is significant here, partly because of the lower (50 kHz) deviation in the television system, and partly because of the necessity of keeping very carefully to this deviation to avoid sound-on-vision interference. Typical signal-to-noise ratios are 45 dB. Dinsel showed that the B-system was very useful in improving the performance; on-air tests at Bayerische Rundfunk showed again that compatibility was excellent. With the growing awareness of the need to improve the sound quality for t.v. productions (as also witnessed by the move to improve audio soundtracks on vtrs and the use of synchronized multitrack audio recorders) this project provoked much interest. Moreover, if stereo pilot tone transmissions are ever adopted for television sound transmission, the noise performance will probably be further degraded, and the Dolby B-Type system will certainly be beneficial.

In England, a series of tests was carried out by the Independent Broadcast Authority (IBA) in the summer of 1976. A total period of one month of partially announced broadcasting took place in Birmingham and London; a 2 dB increase in average modulation level was used. In Birmingham there were no listener reactions, and in London about three inquiry letters were received. The conclusion of these tests must also be that this system of transmission is acceptably compatible. No official decision has yet been announced by the IBA about any future plans.

Tests have also been carried out in Eire, Holland, Norway, the Philippines, Spain, Sweden (11), and Thailand. No decisions have been made yet in these countries except to await developments and in particular to see if consumer equipment with decoding circuits becomes available.

#### CONSUMER EQUIPMENT

There are at present about 20 million Dolby B-Type circuits in world-wide use; these circuits are capable of decoding Dolby f.m. transmissions providing a time-constant change is made in the tuner or receiver. Unfortunately, these circuits are usually inaccessible, being built into cassette recorders and the like. However, decoding can be carried out by recording the transmission with the noise reduction switch off, and then subsequently replaying with noise reduction on. In addition, there are several tape recorders available now with dedicated switches



Figure 6. A printed circuit assembly showing additional components required for Dolby f.m. decoding.

which allow the decoder to be used with external signals. However, these methods are difficult for many consumers to understand and operate correctly. There are also several receivers with 25  $\mu$ sec de-emphasis switches, as well as external time-constant change adaptor boxes; to complement these, several models of free-standing noise reduction units are available.

These methods of decoding filled the need in the 1974-76 period until new designs of tuners with built-in Dolby decoders were ready. By March, 1977 there were 47 such tuner and receiver models with full facilities for decoding Dolby f.m. transmissions; a representative product is shown in FIGURE 5.

Early 1977 also saw the introduction of four new integrated circuits complementing the original 1973 design by Signetics. This had the effect of reducing prices and making it easier for manufacturers to choose the correct device for their particular application. The additional circuitry is simple; FIGURE 6 shows a stereo decoder board ready for addition to a conventional receiver. If an output amplifier is normally fitted in the receiver, the amplifier in the Dolby circuit will replace it so that the added cost is considerably less than that of the decoding circuit components taken by themselves.

All products incorporating the Dolby B-Type system are manufactured and operated in a standardized way. For calibration purposes, a reference tone called *Dolby tone* is used, corresponding to a fixed voltage in a Dolby circuit. For f.m. transmissions, Dolby tone is defined as a deviation of  $\pm 37.5$  kHz at 400 Hz, which gives a 59 per cent total percentage deviation if the transmission monitor

Figure 7. The professional encoder.



measures the pilot tone as well. Owing to the limiting characteristic of f.m., this results in a constant signal level to the decoding circuit. Once factory-calibrated, there is no need for further adjustment by the consumer, and the decoding will be correct for all stations. For calibrating add-on decoders, the tone should be transmitted periodically although a surprisingly accurate calibration can be achieved by simply using the meters on the add-on unit as if they were a level setting meter for a tape recorder.

## TRANSMITTER EQUIPMENT

The professional Dolby encoder unit (FIGURE 7) is simple and requires no special alignment procedures. It may be placed either at the transmitter or at the studio output (which allows noise reduction to be applied to the link from studio to transmitter). Controls are provided for NR in-out, Dolby tone, and for remote operation of these functions. A toggle switch under the front access plate changes the unit from encode to decode (with indicator lights on the front panel) to allow the unit to be used in conjunction with a receiver as a quality off-air monitor. Installation is simple; calibration consists of switching on the internal Dolby tone oscillator and adjusting the output level control for  $\pm 37.5$  kHz deviation, and then adjusting the input level control for unity gain through the device (or for a gain equal to the increase in average modulation level which the 25  $\mu$ sec time constant allows; this gain will be dependent on the previous modulation and signal processing practices of the particular station or organization).

## CONCLUSION

The application of the Dolby B-Type system to f.m. broadcasting is establishing itself among quality-conscious stations in North and South America; European interest is high. For the first time there is available a signal processing system which allows noise reduction and total recoverability of the signal by the listener with little or no detriment to those listeners who do not wish to purchase such a decoder. In doing so, it allows excessive high frequency pre-emphasis, one of the problem areas in f.m. broadcasting, to be corrected in a compatible way for listeners with conventional receivers.

## REFERENCES

1. E. H. Armstrong, "A Method of Reducing Disturbances in Radio Signalling by a System of Frequency Modulation," *Proc. I.R.E.*, Vol. 24, p. 689 (May, 1936).
2. J. G. Spencer and G. J. Phillips, "Stereophonic Broadcasting and Reception," *Radio and Electron. Eng.*, Vol. 27, p. 399 (June 1964).
3. E. W. Hayes and H. Page, "The BBC Sound Broadcasting Service on Very High Frequencies," *Proc. I, E.E.*, Vol. 104, Part B, No. 15, p. 213 (May 1957).
4. W. J. Kabrick, "Preventing FM Overmodulation," *Gates Engineering Report* (1965).
5. R. Berkovitz and K. Gundry, "Dolby B-Type Noise Reduction System," *J. Soc. Electron. Rad. Tech.*, Vol. 8, p. 99 (May/June 1974).
6. D. P. Robinson, "Dolby B-Type Noise Reduction for FM Broadcasters," *J. Audio Eng. Soc.*, Vol. 21, p. 351 (June 1973).
7. R. M. Dolby, "Optimum Use of Noise Reduction in FM Broadcasts," *J. Audio Eng. Soc.*, Vol. 21, p. 357 (June 1973).
8. *FCC Document 25943* (July 10, 1974).
9. Institute fur Rundfunktechnik, *Report No. 130* (Aug. 1974).
10. S. Dinsel, "Dolby B Beim Fernsehton," paper read at meeting of *Fernseh und Kinotechnische Gesellschaft, Saarbrücken* (1975).
11. CCIR Study Programme 15A-1/10, *Document 10/114-E* (April 1976).

MARTIN DICKSTEIN

# Looking at Variable Speech Control

*Speeding up or slowing down recorded speech leads to an array of possibilities.*

**M**ANY YEARS AGO, a famous cartoon/animation production company created a character who “spoke” with a slightly high pitched voice at a rather rapid pace. More recently, a group of singers was made to sound on their recordings like what people thought chipmunks would sound like if they could sing. Here, again, the pitch was higher than what is considered normal, and the speed of the speech was accelerated. Both effects have left their names within the recording field to describe the sound heard when normal speech is played back at faster-than-recorded speed—termed either *Donald Duck* or *Chipmunk*. No such household name seems to have come into popular use for the effect of a tape played slower-than-recorded, but again the words are very difficult to understand and the pitch

---

*db* columnist Martin Dickstein travels extensively, setting up and presenting audio-visual programs.

is correspondingly lowered to a seeming rumble. There are applications, however, in which increased or decreased playback speed would be most useful if the speech sounded at normal pitch and was totally understandable.

Work to develop a method for speeding up playback without loss of intelligibility, still maintaining normal frequency relationships, started in the early 1920's. It was not until just before the 1960's that an operational device was actually developed. The method used was a rotating head with which it was possible to maintain the normal speed relationship with respect to the tape, whether the playback was slower or faster. Thus, normal pitch could



*The Variable Speech Control Co. Model A6. The speed slide control has markings for a range of 0.5 to 2.5 times normal.*

be maintained. In more recent years, other methods were also found to be possible. Devices incorporating such means would require multiple input and/or output channels, tapped delay line or tapped shift register with the speed of tape sampling varying inversely to the relative speed of the tape, random access memory, analog-to-digital and digital-to-analog conversions, or alternate channel sampling, or combinations of these. All of these, although feasible, had drawbacks or were expensive or both.

The need for a viable, less expensive device that could accomplish the desired feat became obvious in many fields of possible application. Just as with speed reading, where comprehension could be increased with faster reading, it was also possible to listen quicker than the rate of normal speech. Average reading speed has been found to be about 300 words per minute. It is now possible for quick skimmers to read at 1,000 words a minute. Similarly, normal speech can range from just over 100 words per minute, to a lecturer at about 125 words a minute, to newscasters at 175 words per minute, to some rapid-fire disc jockeys who seem to beat the clock into complete submission. It would seem, then, that only the mechanics involved in saying the words keeps oral communication down below even normal reading rate. Therefore, if speech could be increased just two times above normal with proper pitch and intelligibility, comprehension would be enhanced, and half the original time could be saved. Especially for people with impaired eyesight who depended on hearing for gaining information, slow speakers can be a hindrance, and artificial speedup is a time-saving boon.

## "I CAN HELP CHANGE YOUR LIFE. BUT I CAN'T HELP CHANGE YOUR SPARK PLUGS."



If you want to find inner peace, come see me. But ask me how to fix a car? You got me. For questions of that nature, you must seek knowledge somewhere else.

A good place would be the Consumer Information Catalog. It is put out by the Federal Government and lists over 200 consumer booklets that one can send away for. Most are free. And they can help you in many areas that I cannot. From raising tomatoes to lowering your fuel costs.

So send for the free catalog. Write: Consumer Information Center, Dept. A, Pueblo, Colorado 81009. That way you won't have to climb a mountain to gain knowledge. You can merely go to your mailbox.

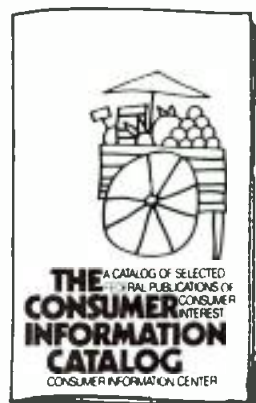

## THE CONSUMER INFORMATION CATALOG

A catalog of over 200 helpful publications.



General Services Administration • Consumer Information Center

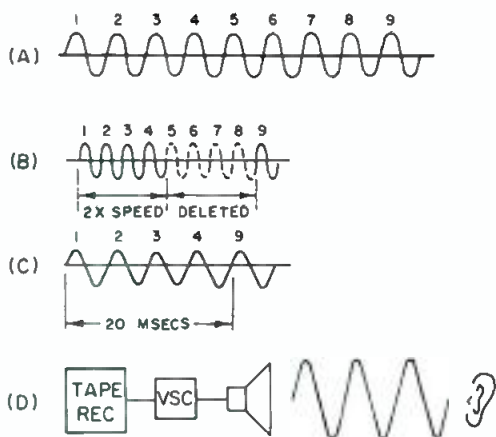

Figure 1. Operation of a VSC is based on the deletion of redundant portions of sound waves and spreading the remaining segments to produce near-normal pitch output of accelerated tape, with a reverse process for slower tape speed. (A) Normally recorded sound wave. (B) VSC-deleted portion of redundant sound wave (10  $\mu$ sec) proportionate to increased or decreased speed. (C) Resulting sound wave reshaped to normal pitch. (VSC restored sample, 20  $\mu$ sec). (D) Output sound wave at normal pitch, whether played fast or slow, using VSC.

## VARIABLE SPEECH CONTROL

The development of *Variable Speech Control* (VSC) came about as the result of one such graduate student who had lost his eyesight asking an engineer to design the necessary circuitry to be able to restore the original pitch and understandability to sped-up tapes. That was in 1960. After unsuccessful attempts to get some large communications companies to try their hand at the development, it was found that a method had been developed at Bell Labs in which a computer broke down speech into 200-Hz bands with 36 filters, and then recombined them at halved frequencies. This allowed for normal-sounding speech at double playback speed. Through the next ten years and with the expenditure of much money, a Massachusetts group tried to develop a working model. In 1976, the Variable Speech Control Co., which was formed in Westport, Conn., bought the technology and rights, and moved to San Francisco early this year.

When a tape is speeded up, the playback time is inversely proportional, and the frequency also changes proportionately. To return the output waveform to its original shape and length, it was necessary to delete portions of the sound wave, and stretch the remaining pieces with proper connections to the succeeding segments. Since speech has a great deal of redundancy in its sound patterns, cutting out small segments did not really destroy the intelligibility. This can be shown experimentally by successive razor cutting of a tape on which speech has been recorded. If the pieces taken out are short enough, and the tape then played back at normal recording speed, the speech will seem to flow by faster, but with proper pitch and complete understandability.

Since redundant portions of speech can be about 100 milliseconds long, cutting segments of up to 40 milli-

seconds will not play havoc with the flow the ear will hear. Thus, it is possible to delete small portions electronically, tie the remainder together, and allow the playback speed to be increased without loss of continuity. By sampling and cutting in proportion to the increase in speed of the tape, the sound will seemingly flow smoothly at normal pitch. Similarly, but in reverse, slower tape samples also had to be taken, the longer sound patterns that were stretched out had to be shortened, and the output waves returned to natural sound. Between the shortened signals there were gaps, which, if longer than about 5 milliseconds, became disturbing. These could be filled with redundant sound, or quick repetition of the previous sound until the next sample passed through.

## EXPANDING/CONTRACTING

To accomplish this sampling, cutting, and expanding or contracting effect, a frequency processor and control circuit are inserted into the system between the preamp and the amp. The processor sets up the electronic delay to correspond with the speed of the tape. In a speed-up, the delay is increased continuously. To compensate for a slowed tape, the circuitry provides an ever-decreasing delay.

In the VSC system, the audio feeds through an analog shift register with a 256-bit (or more) capacity. By switching the device at a geometrically progressing rate from one frequency to another, the sound can be regained at normal pitch due to the delay time changing accordingly and the frequency components also changing by the same ratio with harmonic relationships retained. If the switch rate is decreasing, it takes longer for later bits to pass through than for the previous ones. The waveform is stretched and the frequency decreased accordingly. For slower tape speed, the sweep is from low to high frequency, the delay is shorter, the frequency is raised accordingly.

The i.c.-based system contains 512 stages in the shift register. The production devices consist of two chips with 200 transistors. By developing special circuitry and devices, the VSC system has been able to avoid shifting analog-to-digital and back again, and has designed a modular system which can be inexpensive enough to license to other manufacturers to add to their own models of tape machines. The Variable Speech Control Co. offers a Model A6 unit, an a.c. powered VSC-equipped cassette tape recorder with speed ranges from 0.6 to 2.5 times normal. It sells for \$295.00, directly from VSC Co. They also sell a pitch-correction module, Model M7, which costs \$125.00, and a limited-production unit, System 3 Module, which incorporates highly sophisticated circuitry for higher signal-to-noise, wider bandwidth, and maximum quality intended for professional use. The dynamic range is greater than 70 dB.

## AVAILABLE MODELS

Licenses of this patented system include Sony, Panasonic, and Magnetic Video Corp. The latter produces a Model CC-103 recorder/duplicator cassette unit with speeds from 1 to 2.5 times normal. Panasonic is producing a unit with speeds of 0.5 to 2.5 times normal. La Belle Industries is applying the system to its Courier 16 AV Filmstrip Viewer to speed up or slow down presentation of 16mm or 8mm strips in sync with the sound. The American Printing House For The Blind is producing a module similar to the VSC Model M7 but available only to visually handicapped people for use in tape recorders



or phonographs. (Note that speeds below 0.5 or above 2.5 times normal are not used because speech beyond these limits were found to become unintelligible, although the pitch remained good.)

According to the specifications on the Model A6 Speech Controller cassette recorder, it contains a built-in condenser microphone, 3-digit counter, cue and review system for quick location of desired audio sections, pause control, end-of-tape auto stop system, a vu meter, and automatic level control. The unit is designed to record only at normal speed. The machine has the normal dual track, monaural audio system with provision of external jacks for accessory microphone, remote on/off switch, earphone, and headphones. The frequency response is 150 to 5,000 Hz. Speed deviation is with 1 per cent and the s/n ratio more than 40 dB. The unique control on this machine compared to the usual cassette recorder/player, is a slide lever near the slide volume control for speed regulation.

### APPLICATIONS

Uses for a module or machine with VSC capability seem almost limitless. For the blind, of course. Also for students who can record lecturers in real time and play them back in altered time, or can get recorded cassettes on special courses from the university libraries to which the same treatment can be applied. It is estimated that there are something like 2 million visually handicapped persons in this country, and about 10 million students. All sorts of professionals, including doctors and nurses can keep up with the latest developments by audio cassette, business men or salesmen are enabled to keep tabs on leads, students can remain involved in continuing education or training courses even while traveling. It is estimated that the 300,000 doctors in the U.S. are the largest group of VSC users, with the visually handicapped second.

Further application is in business for dictation and replay for typing, in training, government, language studies, and for police work. As a sidelight on investigative possibilities, it is well known that when people are speaking hysterically, it is often impossible to understand them. Recording their voices and showing down the playback to bring out the information will create a useful tool not only for police interrogation but in other instances, such as the need for attorneys, reporters, and medical personnel to obtain accurate information in a crisis situation. The flexibility of the VSC could be most useful to broadcasters, making it possible for them to shorten or lengthen programs or commercials to fit specific time slots in the schedule.

Future applications will probably be made in video machines, audio visual devices to keep picture and sound together for a variety of special effects. With the inclusion of a greater number of integrated chips and more sophisticated circuitry, a greater decrease in noise for a higher s/n ratio and extended frequency suitable for video broadcasting and home hi-fi systems will be possible. One area where the VSC might not be suitable is in the reproduction of music, where it is not possible to cut out any segments at all during a speed-up or slow-down of tape play without loss of musical continuity. Curiously, this very characteristic of music can lead to unique creative expressions done with the VSC, deliberate distortions resulting in eerie or space-sounds, even a whole new process of musical composition, using special filters, the latest electronic musical instruments, and computers. ■

## New! NOW-TOTAL VISUALIZATION OF TRACK INFORMATION AT YOUR FINGER TIPS. FOR ONLY \$39.50

NEVER MOUNT ANOTHER BLANK MAGNETIC TAPE AGAIN.



With the Plastiform Magnetic Tape Viewer, you have a fast, clean way to see recorded signals on magnetic tape. You can use it to determine, record or reproduce problems in malfunctioning systems. Resolution of standard level analog recording to 500Hz at 7.5 I.P.S.

- Check accuracy of track placement and check alignment
- Pulse definition
- Synchronize audio track on video recorder
- No tape deterioration
- No messy chemicals

**ORDER TODAY** Every station and studio requires the Plastiform Magnetic Viewer. Send just \$39.50 to the PERMAG nearest you.

DISTRIBUTED BY



PERMAG DIXIE CORP. 19 9th St. N.W. Atlanta, Georgia 30318 • 404-351-9994  
 PERMAG PACIFIC CORP. 441 West 104th St. Los Angeles, Calif. 90044 • (213) 776-2626  
 PERMAG CENTRAL CORP. 1213 Estes Ave. Elm Grove, Wis. 53122 • 414-956-1400  
 PERMAG NORTHEAST CORP. 10 Fortune Drive, Billerica, Mass. 01821 • 617-273-7890  
 PERMAG SIERRA CORP. 159 Sandoz Court, Sunnyvale, Calif. 94086 • 408-738-1080  
 PERMAG SOUTHWEST CORP. 2720 Javor St. Dallas, Texas 75276 • (214) 748-6909  
 PERMAG MAGNETICS CORP. 2960 South Ave. Toledo, Ohio 43609 • (419) 385-4621  
 PERMAG CORP. 88 06 Van Wyck Expressway, Jamaica, N.Y. 11478 • 212-657-8818

Circle 23 on Reader Service Card



### GARNER TAPE ERASERS

provide clean erasures in only four seconds—with no noise residue. Tapes are wiped cleaner than new. Our simple, safe, continuous belt operation handles all sizes of reels, cartridges and cassettes. Several models: Up to 16". Also Video Erasers.

Garner Erasers are now fulfilling the exacting requirements of many major organizations around the world...yet are so low priced that the smallest studio or station can afford one.

*User reports...* "It is a big improvement over what we used to use, or anything else on the market today."

—Ric Hammond, KNX Radio (CBS), Hollywood, Calif.

Call today or write for brochure.



### GARNER INDUSTRIES

4200 N. 48th St., Lincoln, NE 68504. Phone: 402-464-5911

Circle 21 on Reader Service Card

SIDNEY S. SMITH

# Stereo Vectorscope: See What You Hear

*An oscillosgraph pictorializes the direction and amplitude of stereo perception.*

**W**HEN ANALYZING STEREO INTERRELATIONSHIPS, the binaural perceptions of hearing in the spatial environment are sometimes acute. But they are also subject to the unreliability inherent in the hearing process. Psycho-acoustic variables such as fatigue, physical well-being, emotional colorings, a lingering memory of some other sound just heard, are some of the factors which tamper with the objective appraisal of what we are hearing. Hearing alone as a measuring device is subject to so many variables, its accuracy is questionable. Yet, because of the inadequacy of v.u. meters in indicating stereo interrelationships, major judgments at the console are still largely made through unaided listening.

Realizing that an additional check on what they are hearing is necessary, some engineers have enlisted another sense, sight, for their observations, with the use of pictorial devices, the X, Y lissajou displays created with oscillo-

---

*Sidney S. Smith is president of the S. S. Smith Company. Sea Cliff, N.Y.*



The Stereo Vectorscope, Model SV1

scopes of one kind or another. (Most have eventual burn-out center spots.)

Good training with lissajou figures supplies the capacity to observe a great deal of information. But this mass of information is also quite confusing in many cases, failing to emphasize the items of concern.

While developing the oscilloscope displays for the Sequerra tuner, I developed a system to display four-channel stereo with each adjacent pair of signals displaying within its own quadrant. At the time, a system was independently proposed which rectified the signals from a matrix but in so doing left the spot standing for half the time on the lines dividing the quadrants. Our system keeps the spot moving and also indicates the out-of-phase components between adjacent pairs of signals.

### LOCALIZATION

The basic concept was displayed in a prototype tuner at the Hi Fi show in New York City in 1972. Further experience with this display has convinced me that this would be a valuable professional tool for recording and broadcast engineers. In 2-channel use, it is superior to a lissajou display because it indicates localization with a ray or vector from the zero point and is matrixed to show left and right in their correct directions.

An instrument which consists of a signal processing circuit feeding into an X, Y, Z monitor oscilloscope has now been developed. We call it a *Stereo Vectorscope* because it selects and displays, as vectorial, or directional indica-

## Another Limiter?

So ask the cynics. That's why we made the Orban/Parasound 418A special. It's a stereo compressor/limiter/high-frequency limiter system that compresses the dynamic range of complex program material with astonishing subtlety and freedom from side-effects. It simultaneously and independently controls the high frequency energy to protect preemphasized media (like disc, cassette, and optical film) from high frequency overload distortion. It's cleaner than most linear amplifiers (THD at 1 kHz is typically 0.02% for any degree of gain reduction), and stereo tracking is locked-in for life without adjustments.

The 418A is highly "smart" and automatic. There are only three controls that affect the sound quality. This means that the 418A can speed the process for budget-conscious customers (like commercial producers) and bring them back again and again. The 418A is also ideal in the broadcast production studio ahead of the cart recorder, where it guarantees clean carts, free from over-

load and high frequency saturation due to excessive EQ.

The recording studio can use the 418A to generate master tapes which will transfer to disc and cassette gracefully and cleanly. The subtle, dynamic high frequency control means that high frequency equalization can be used more freely than ever before without danger of overload. The cassette duplicator and optical film recorder can condition problem masters to maximize signal-to-noise and eliminate high frequency splatter in these touchy and demanding media.

The Orban/Parasound 418A isn't "just another limiter"—it's a time-saving system that handles chores ordinary limiters can't touch. It's available at your Orban/Parasound dealer.

**orban/parasound**

680 Beach Street, San Francisco, CA 94109

(415) 673-4544



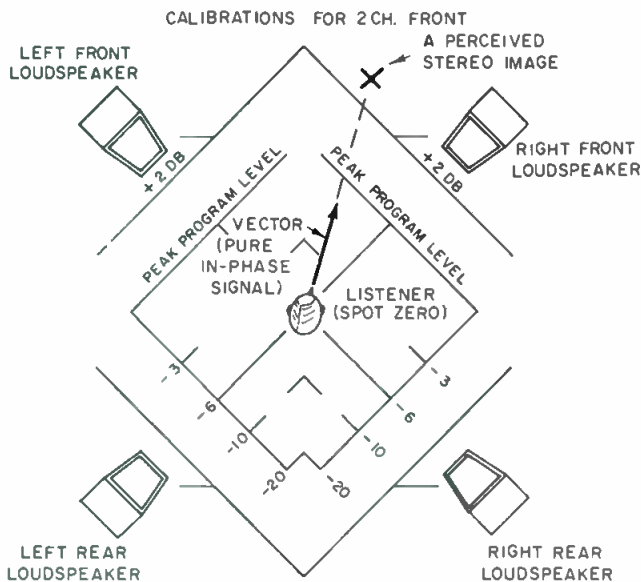

Figure 1. An equivalence to listening in four channel sound, a top view.

tions, those elements of phase and amplitude within the stereo signals that give the ear its directional sense. In fact it seems to correspond closely to the actual angles that would be perceived if the listener diagrammatically saw himself from above as if at the origin or zero point and the loudspeakers in 45 degree diagonal directions from the center line (see FIGURE 1). Electrically panned signals will show vectors in angles similar to the perceived direction with their length proportional to the signal strength. The unit has a full four-channel capability if desired, and will indicate in all four quadrants with four signal inputs. Monophonic signals (the same signal on two adjacent channels) will show vectors on center between the assumed 45 degree vectors to each speaker.

Between any pair of adjacent signals as relative phase changes, elliptical segments are displayed. Finally, as the phase approaches 180 degrees, if the amplitudes are similar, the signals will show *outside* the original quadrant as "corners" spreading at right angles to the reference monophonic line.

Figure 3. A complex two channel front signal that is out of phase.

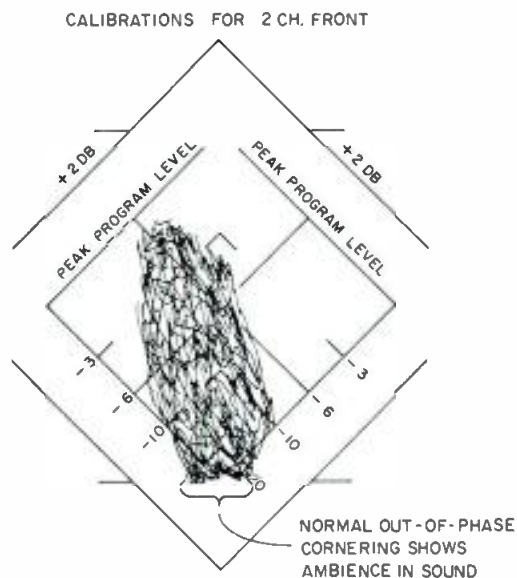
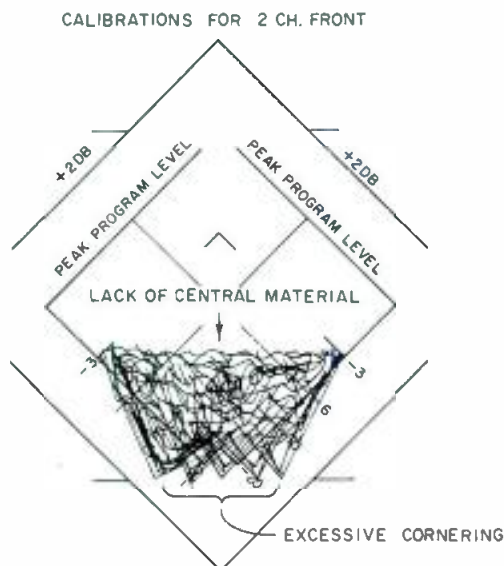

Figure 2. A normal complex type two-channel front signal, mostly in phase.

The recently developed Stereo Vectorscope has a dynamic "Z axis" intensity modulation circuit. This brightens the trace on peaks and dims the trace every time it passes its zero signal spot location. This may seem to create a "burned out" effect in the spot area, but the purpose of the circuit is to enhance the observance of signal peaks and to protect the life of the cathode-ray tube.

### MONOPHONIC COMPATIBILITY

If complex material is heard and monitored simultaneously, as particular instruments or groups "solo," their directions are indicated in visual bursts from the continuing total mass. It becomes easy to recognize the acoustic stereo mix versus mono-panned mixes. A surprising amount of recorded stereo pop music has one left channel group and one right channel group of accompanying instruments with a central mono soloist and no acoustic mix at all. This type of arrangement is quickly recognized visually.

Sometimes a soloist will be deliberately added, out-of-phase, for effect. A pattern composed of little circles superimposed on the main 2-channel conglomerate probably indicates SQ. matrixing. Of course, a decoder will have to be introduced to see the eventual 4-channel pattern.

The amount of in-phase mono material in stereo broadcast signals has become an extremely important element, giving the station the "monophonic compatibility" which means more effective use of the transmitted power to distant receivers. This is a decidedly important dollars-and-cents issue. It will be of extreme importance should the new a.m. stereo proposals become operative.

### OUT-OF-PHASE STEREO

It is a continually fascinating observation that so much recorded material has out-of-phase stereo components either on records or sometimes as broadcast with reversed lines. If this condition is suspected, careful listening in an acoustically proper environment will eventually reveal the out-of-phase situation. However, a fast glance at the Stereo Vectorscope will indicate the situation quickly. The finding is generally confirmed without question when a reversing switch allows comparison in the display. These phase indications are generally obvious, but sometimes they are astonishing (see FIGURES 2 and 3).

While demonstrating this device to broadcasting engineers who have had wide experience with many different

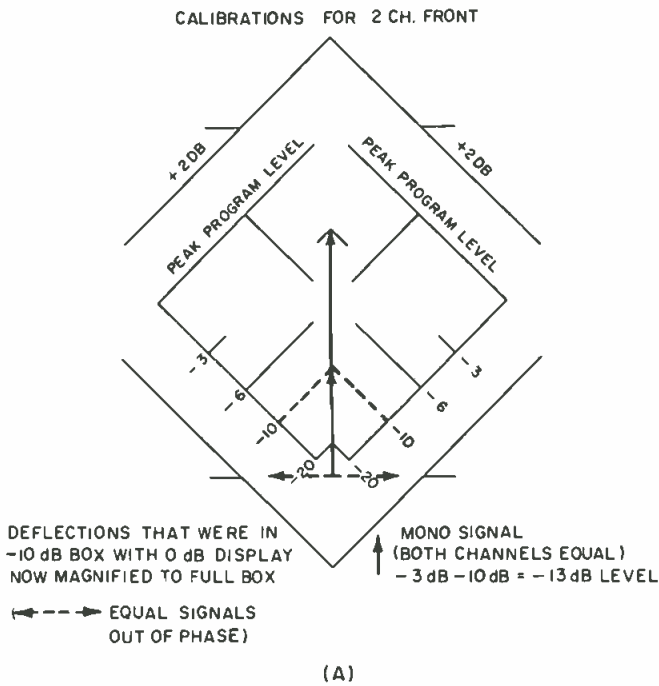

(A)

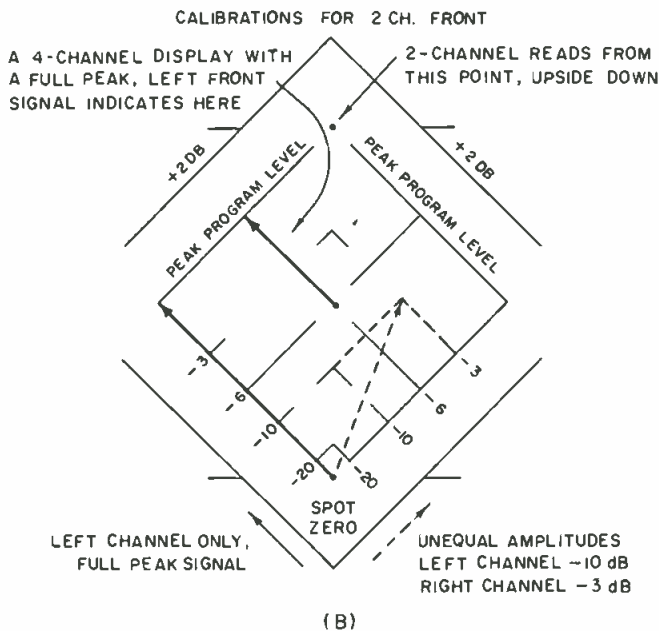

(B)

Figure 4. (A) Measuring vectors in phase, 10-dB gain, two-channel front signal. At (B) the gain is zero, with, again, a two-channel front.

recordings, it has been very gratifying to reveal that some suspected recordings are so overprocessed that they actually show no monophonic preference, either in- or out-of-phase. If broadcast, they would not project good monophonic signals. On the other hand, there were recordings the engineers hesitated to use because they had suspicions of this failing when tested; they were shown to have excellent monophonic power.

Another use for the Stereo Vectorscope is at recording sessions on location. We feel that the device should be able to save much valuable time. Placement and phasing of microphones as they add into the complex can be quickly clarified, speeding the engineers' setup.

The Stereo Vectorscope can be used in lieu of a lissajou display for any common purpose. Since its normal deployment is continually across the program line, it is convenient for the recognition of such problems as separation, balance of lines (telephone lines notoriously change with-

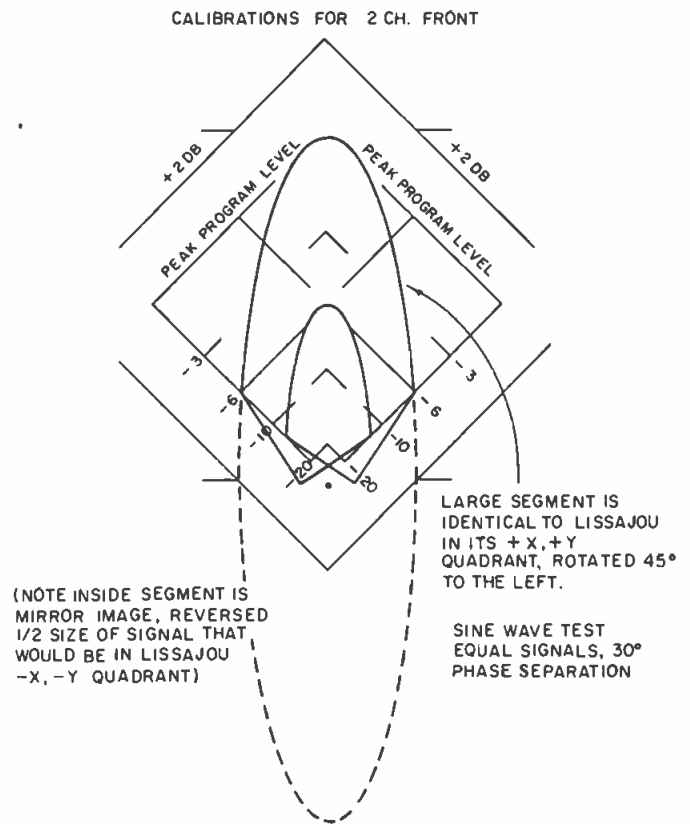

Figure 5. A two-channel front sine-wave test with equal signals and 30 degrees phase separation.

out notice), azimuth alignment of tape heads and the dynamic alignment of phono cartridges. It can also give a quick indication of noise problems, even in a split-second pause between selections or speech, by switching to the 20 dB gain position. Since the visual indication of noise on the pattern is pretty simple down to about  $-34$  dB, the added 20 dB gain can show down to  $-54$  dB below peak program levels.

New York City Station WNCN, now broadcasting some of the highest quality classical music, is setting up to use one Stereo Vectorscope to monitor the program line out of the studio and another to monitor the signals into the transmitter. If any problems occur on the line or in the limiters, the station engineer can check back to the studio for comparison.

#### FOUR-CHANNEL SIGNALS

This display was developed to indicate 4-channel signals in their own quadrant. If half-wave rectifiers are used with a matrix, the spot draws four diagonal lines or stands still during big signals and tends to burn lines into the screen. It also, of course, has no indication at all of what happens during negative excursions. If full-wave rectification is used, the spot will turn around at each rectification but there will be no indication of out-of-phase since a full wave rectified signal knows no difference.

This circuit uses a one to one-half amplitude relation between rectified phases, which we loosely refer to as *three-quarter wave rectification* because it lies between one-half wave and a full wave. This results in an out-of-phase indication smaller and at right angles to the in-phase or "mono" signal (see FIGURE 4A). This double-direction vector outside of the listening quadrant seems to bear some analogy to the listening experience. In-phase signals show a large, and then half-sized, vector superimposed. The interesting result has been not only a practical 4-channel display but, perhaps more importantly, a very effective 2-channel dis-

play for a single quadrant. Its graticule is specifically calibrated for the latter use.

### INSTANTANEOUS PEAKS

The positive, in-phase instantaneous peaks are very obvious in this instrument, with its Z axis enhancement. They can be measured very well from the calibrations on the graticule and allow for +2 dB over the peak program level if the input gain adjustments are properly set. Of course, as with any peak reading device, the user must establish what peaking factor he requires over the average zero dB level. The difference in seeing each instantaneous peak, versus the time delayed hold, in types of peak panel meters is remarkable.

Since the Stereo Vectorscope measures the amplitude of in-phase, positive signal peaks, the efficacy of measurements will be improved if microphones are phased to produce positive voltage peaks with increasing pressure. This is especially true since speech and some music tend to be non-symmetrical with positive peaks exceeding the negative peaks in amplitude.

In 4-channel use, the zero point is shifted to the center of the graticule and the length from zero to peak program level is one-half of the two-channel use (see FIGURE 4B). The internal gain of the Stereo Vectorscope has been cut in half to maintain the 100 per cent calibration. Of course, the user must now estimate proportional calibrations for other amplitudes. The +2 dB line for 2-channel now becomes +3.6 dB for 4-channel use.

### 4-CHANNEL DIRECTION

In 4-channel listening, if the *same* signal is on diametrically opposite speakers, a loud signal may occur *but it has no direction*. In 4-channel operation, with the Stereo Vectorscope, such a signal is cancelled in the matrix and no vector will show. Only directional material will produce vectors. The 4-channel position must not therefore, be used for v.u. indications if similar signals can occur at opposite inputs. It does indicate the *directional* information very effectively.

### Notes on the Stereo Vectorscope

The vectorscope described in this article was used for several days in my four-channel studio. With it I monitored input and output signals in both stereo and multi-track recording and playback. The peak calibration of the graticule is quite exact, and, used with the three-position switch for gain, results in visualizations of well over 40 dB of dynamic swing. The patterns shown in the accompanying drawings represent what the unit will show. The layout of controls on the remote control are simple to use, and logical.

That remote control also serves as the connection for wiring to a console. It is equipped with a barrier-strip connector system for the four channel inputs, balanced or unbalanced. In addition, there are four phono-jack inputs for quick or temporary connection to unbalanced lines.

The remote control also contains a reverse-phase switch that is spring-loaded to return it to normal. This facilitates the study of stereo information for mono phase compatibility.

Finally, the vectorscope seemed stable and reliable in its construction and design.

L.Z.

Frequency is not indicated in any way in the basic instrument. Sometimes the characteristic display of typical acoustic mixes shows textures identifiable with high frequency percussions. As with any lissajou patterns, distortion and clipping components are not well-defined unless they occur differentially. The vector may not be altered by equal clipping to the signal in both channels. However, limiting that occurs in one channel shows as an obvious change in direction of the vector.

### DEFLECTIONS

A single signal on one of the 45 degree source vectors should follow the line. Any signal on the other channel will show deflections above (and some below) that line. Of course, as in measuring the amount of each component, a lack of full separation will be a deflection away from the line. If a test signal is applied in amplitude to reach the peak program level line, the *separation* in dB will be the signal amplitude as read on the opposite line.

The measurement of phases will follow that of lissajou measurements if the large segment and its end points are observed. If the signal levels are adjusted for the signal peaks to tangent at the peak program level lines, intersections with the -20 dB fiducials will mean 5.7 degrees; the -10 dB points, 18.4 degrees; -6 dB points, 30 degrees; and -3 dB points, 45 degrees. 90 degrees is indicated by tangency at the 45 degree intercepts (see FIGURE 5). From 90 degrees to 180 degrees, the measurement can be made as the complements of a switched, phase reverse measurement made in similar fashion.

### SPECIFICATIONS

The unit, designated the Stereo Vectorscope SV1, is designed to operate in conjunction with, and powered through, the line connection of the Tektronix 604 monitor. The 604 has been modified to do this and a modified bezel, which contains a special blue filter and an illuminated graticule is installed.

The optional remote control device, RC1, is a small unit with a standard 7 x 1½ inch panel which can be installed in a standard console fader space at a position conveniently available to manual switching which connects with, and can control, the Stereo Vectorscope when it is placed above the console at a visually convenient location.

Panel controls for the SV1 are: power on-off; 2-channel front; 4-channel; 2-channel rear; gain; 0 dB; 10 dB; 20 dB. There are indicator l.e.d.s to warn if the gain has been increased, thereby making monitor of peak program level impossible; screwdriver adjustments are available, if needed. Other settings include focus: vertical, horizontal; a setting for undeflected spot intensity (set dim); an intensity range adjustment; and a spot shift for setting the spot position when it is shifted from center for 2-channel displays. The input adjustments, located under a small cover plate with the SSS monogram, should be covered when not in use to prevent inadvertent readjustments after the initial set.

Experience in using the unit demonstrated the need for continual switching, particularly for the gain, the need for a much-used phase reverse switch and the desirability of adding a demonstration circuit to indicate vector positions. Therefore, we developed the optional remote control unit, RC1, to simplify these operations.

The SV1 and RC1, including the Tektronix 604 monitor, are available from the S. S. Smith Company as a combined unit. The device is 10-1/2 in. high, 5-3/16 in. wide, 19-1/4 in. deep, and weighs 21-1/2 pounds. We have found that, despite the complex technical description, it is quite easy to install and intuitively simple to use. ■

Closing date is the fifteenth of the second month preceding the date of issue.

Send copies to: Classified Ad Dept.

db THE SOUND ENGINEERING MAGAZINE

1120 Old Country Road, Plainview, New York 11803

Rates are 50¢ a word for commercial advertisements.

Employment offered or employment wanted ads are accepted at 25¢ per word.

Frequency discounts: 3 times, 10%; 6 times, 20%; 12 times, 33%.

db Box number: \$1.00 per issue.

All classified ads must be prepaid. Frequency discount advertisements are to be prepaid in advance.

## FOR SALE

**TRACKS!!** The complete semi-pro recording center. Check our low prices on Tascam, TEAC, Neotek, Micmix, dbx, Multi-Track, MXR, Sennheiser, BGW, Shure, TAPCO, and many others. Complete studio packages available. **TRACKS!!** from DJ's Music, Ltd. 9520 47th St., Brookfield, Ill. 60513. (312) 485-0020.

### PRO AUDIO EQUIPMENT & SERVICES

P.A. and custom touring sound systems, studio equipment, and turnkey installations, theatre and disco sound. Representing over 100 lines, including: AKG, Allen & Heath, Alembic, Community Light & Sound, dbx, Denon, Dokorder, Dynaco, Emilar, ESS-Pro, E-V, Forsythe Audio, Fons, Furman, Gallien-Kruger, Gale, Gauss, Goldring, Grace, J&H Formula 4, Kelsey, Koss, Lamb, Langevin, 3M, 3A, Marantz, Meteor, Mitsubishi, Maxwell, Malatchi, MXR-Pro, Otari, Russound, Revox, SAEC, Sennheiser, Scotch, Shure, Sonab, Sound Craftsman, Soundcraft, Sound Workshop, Sony, Switchcraft, Sesscom, Stax, Supex, TAPCO, TDX, Tascam, Technics, TEAC, Thorrens, Uher, West Penn. All equipment on display in a working environment. Competitive pricing and comprehensive service.

K&L Pro Audio, 75 N. Beacon St., Watertown, Mass. 02172  
(617) 926-6100 (Att. Ken Berger)

**PIEZO SUPER TWEETERS.** Good quantities in stock; specifications sent if requested. \$4.62-\$9.50, depending on quantity. **Musimatic, Inc., 4187 Glenwood Rd., Decatur, Ga. 30032. (404) 289-5159.**

**TASCAM 80-8's** in stock; Loft Modular recording consoles; AKG, Shure, E-V, and Sennheiser microphones; AKG reverb; Eventide; Crown; Parasound; Sentry III's and IVB's. Call today, ask for Ben at **Rowton Professional Audio, Paducah, Ky (502) 898-6203.**

**SOUNDCRAFT MIXING CONSOLES** for recording and sound reinforcement available exclusively in New England at: **K&L Pro Audio, 75 N. Beacon St., Watertown, Mass. 02172. (617) 926-6100.**

**AST: THE PROFESSIONAL SOUND STORE.** Full line of ALTEC, CROWN, CERWIN-VEGA, E-V, GAUSS, SHURE, SUNN, and ATLAS pro sound equipment; factory authorized service on most speakers. Large stock of ALTEC, CERWIN-VEGA and E-V replacement diaphragm assemblies available. **AST, 281 Church St., New York, N.Y. 10013. (212) 226-7781.**

### FREE CATALOG & AUDIO APPLICATIONS



CONSOLES  
KITS & WIRED  
AMPLIFIERS  
MIC, EQ, ACN, LINE,  
TAPE, DISC, POWER  
OSCILLATORS  
AUDIO, TAPE BIAS  
POWER SUPPLIES

**OPAMP  
LABS INC.**

1033 N. SYCAMORE AVE.  
LOS ANGELES, CA. 90038  
(213) 934-3566

**SOUND SYSTEM** design and installation, loudspeaker enclosures for professional applications, custom passive crossover assemblies, room equalization, road equipment cases, touring sound rental. **K&L Pro Audio, 75 N. Beacon St., Watertown, Mass. (617) 926-6100.**

**24-CHANNEL Sound Reinforcement Mixer,** 100-ft. snake, balanced input, 3-band eq., 3 submixers, monitor, echo, solo. Also UREI Model 527A Graphic Equalizer. Best offer! **BC&G Enterprises, P.O. Box 1036, Littleton, Colorado 80160. (303) 751-5991.**

**THE LIBRARY . . .** Sound effects recorded in STEREO using Dolby throughout. Over 350 effects on ten discs. \$100.00. Write **The Library, P.O. Box 18145, Denver, Colo. 80218.**

**MEASURE REVERB TIME IN REAL TIME**—instantly! New, easy-to-use RT-60 delivers precise, instant real time digital readout. Eliminates chart recorder analysis. Only \$460. Write: **Communications Company, Inc., 3490 Noell St., San Diego, Ca. 92110.**

**REELS AND BOXES 5" and 7" large and small hubs; heavy duty white boxes.** **W-M Sales, 1118 Dula Circle, Duncanville, Texas 75116. (214) 296-2773.**

**LIGHTING DIMMER SYSTEM** for sale. 32 — 3k dimmers, 32 faders with 16 preset memory console. Packed for touring. Must sell! **BC&G Enterprises, P.O. Box 1036, Littleton, Colorado 80160. (303) 751-5991.**

**TERRIFIC BUY**—Revox in original packing. Best offer or swap for equivalent in cassette system. **Bunnemeyer, 164 Nassau St., Princeton, N.J. (609) 924-0167.**

**\$2 MILLION USED RECORDING EQUIPMENT.** Send \$1.00 for list, refundable, to **The Equipment Locator, P.O. Box 99569, San Francisco, Ca. 94109.**

### CLASSES IN MUSIC RECORDING

Record Production  
Publishing  
Disc Mastering  
Film Recording

Taught by famous engineers and producers. Held in 16/24 track recording studios.

**University of Sound Arts**  
2040 Avenue of the Stars  
Century City, CA. 90067  
(213) 553-4742

## FOR SALE

MAXELL, AMPEX, Capitol and Columbia reel tape; bulk and custom loaded. Custom length duplicator cassettes. Reels, boxes, leader tape, splicers. For complete catalog, write **Omego Audio Products, Box 39253, Redford, Michigan 48239.**

AUDIOARTS ENGINEERING parametric equalizer, electronic crossover, disco mixer, stage mixers. **Audioarts Engineering, 286 Downs Rd., Bethany, Conn. 06525.**

RAZOR BLADES. single edge; tape editing. **RALTEC, 25884 Highland, Cleveland, Ohio 44143.**

MODERN RECORDING TECHNIQUES by Robert E. Runstein. The only book covering all aspects of multi-track pop music recording from microphones through disc cutting. For engineers, producers, and musicians. \$9.95 prepaid. **Robert E. Runstein, 44 Dinsmore Ave. Apt. 610, Framingham, Mass. 01701.**

RACK LABS active fixed or variable frequency crossovers, disco mixers, and ULF (subsonic) filters. Write: **136 Park St. New Haven, Ct. 06511.**

TASCAM, TEAC, Sound Workshop, Nakamichi, Otari, dbx, MXR, Dynaco, ADS, Eventide, E-V, Shure, Maxell, Ampex, AKG Pro, Beyer, UREI, Stax, Sennheiser, TAPCO, BGW, and more! Send for price quotes. **Zimet Pro Audio, Dept. DB, 1038 Northern Blvd., Roslyn, N.Y. 11576.**

STUDIO SOUND—Europe's leading professional magazine. Back issues available from January '74 through June '75. \$1 each postpaid. **3P Recording, P.O. Box 99549, San Francisco, Ca. 94109.**

MEASURE ROOM ACOUSTICS professionally. Acoustilog's Model 232 Reverberation Timer incorporates the following advantages: one-person operation, 3% accuracy, internal pink noise generator, 3-digit readout. **Acoustilog, 19 Mercer St., New York, N.Y. 10013. (212) 925-1365.**

AMPEX AG-440-2 in console, PR-10-2 in case, MX-10, \$3,000 complete. **Howells Audio Laboratory, 10 Old Woods Rd., Brookfield Center, Conn. 06805. (203) 775-4291.**

### NAGY SHEAR-TYPE TAPE SPLICERS



FOR CASSETTE 1/4 & 1/2 IN. TAPES  
• HAND-CRAFTED  
• FIELD PROVEN  
• FAST, ACCURATE  
• SELF-SHARPENING

**NRPD Box 289 McLean, Va. 22101**

### INCREASE YOUR USABLE P.A. SYSTEM'S POWER WITH BODE FEEDBACK SUPPRESSOR, MODEL 741XR

Also featuring a complete line of studio and performance frequency shifters. For details contact:

**Bode Sound Co.  
1344 Abington Pl.  
N. Tonawanda, N.Y. 14120  
(716) 692-1670**

AMPEX TAPE. Ampex Audio studio mastering tapes; 631-641, 406-407, and "Grand Master" in stock for immediate shipment; 1/4", 1" and 2"; factory fresh. Best prices. **Techniarts, 8555 Fenton St., Silver Spring, Md. 20910. (301) 585-1118.**

AMPEX SPARE PARTS; technical support; updating kits, for discontinued professional audio models; available from **VIF International, Box 1555, Mountain View, Ca. 94042. (408) 739-9740.**

CUTTERHEAD REPAIR SERVICE for all model Westrex, HAECO, Gramplan; modifications done on Westrex. Avoid costly down time, maximum 3-day turnaround upon receipt. Send for free brochure: **International Cutterhead Repair, 194 Kings Ct., Teoneck, N.J. 07666. (201) 461-8658.**

TECHNIARTS, professional audio equipment: AKG, Ampex, Crown International, dbx, Malatchi, Orban Parasound, Sescam, in stock. Professional audio services: audio and acoustical analysis, narrow band equalization, reverberation time, frequency response, and noise level measurements, broadcast and recording systems design, fabrication, and installation. **TECHNIARTS, 8555 Fenton St., Silver Spring, Md. 20910. (301) 585-1118.**

AMPEX, SCULLY, TASCAM, all major professional audio lines. Top dollar trade-ins, 15 minutes George Washington Bridge. **Professional Audio Video Corporation, 342 Main St., Paterson, N.J. 07505. (201) 523-3333.**

### AUDIO and VIDEO On a Professional Level

Lebow Labs specializes in equipment sales, systems engineering, and installation—full service and demonstration facilities in-house. We represent over 200 manufacturers of professional and semi-professional equipment for recording, broadcast, sound reinforcement, and for commercial sound. Call or write for information and pricing.

**LEBOW LABS, INC.  
424 Cambridge St.  
Allston (Boston) Mass. 02134  
(617) 782-0600**

CROWN INTERNATIONAL. Complete repair, overhaul, and rebuilding service for current and early model Crown tape recorders and amplifiers. New and reconditioned recorders in stock for immediate delivery. Used Crown recorders purchased and accepted for trade in. **TECHNIARTS, 8555 Fenton St., Silver Spring, Md. 20910. (301) 585-1118.**

THE RESONATOR is more than a reverb. Designed for use with any console, including Tascam. \$359.00. **Dyma, Box 1697, Taos, N.M. 87571.**

TEST RECORD for equalizing stereo systems. Helps you sell equalizers and installation services. Pink noise in 1/3 octave bands, type QR-2011-1 @ \$20. Used with precision sound level meter or B & K 2219S. **B&K Instruments, Inc., 5111 W. 164th St., Cleveland, Ohio 44142.**

SOUND WORKSHOP mixing consoles, reverbs and support equipment setting new standards in the semi-pro industry available in New England at: **K&L Pro Audio, 75 N. Beacon St., Watertown, Mass. 02172. (617) 926-6100.**

NEW CUSTOM CONSOLE, factory warranted, original customer unable to take delivery. Construction stopped at point where expansion above original 10-in/8-out configuration is possible. 3-band/9 frequency equalizer on inputs and echo return. Ultra-quiet electronics with +26 dBm output. Terms available. Call **Gordon: Clark Research Co., 59-101st St., Ft. Lee, N.J. 07024. (201) 947-4810.**

3M M-56 8 TRACK TAPE RECORDER. Heads excellent. Remote control and snake included; \$6,500. **(213) 786-5696 (213) 783-9634. Back Room Recorders.**

### FACTORY CLOSEOUT SALE

BGW Systems, Inc. is clearing out existing inventories of discontinued products. The following items are offered at 50% of original advertised price: Model 201 preamplifier—straight line (no tone controls) two phono, two tape, tape-to-tape dubbing, 82 dB S/N. Price \$274.50.

Model 1500 power amplifier—monaural power amplifier. 875 W @ 2 ohms, 550 W @ 4 ohms continuous power. Price: \$799.50. Model 4X250—4-channel power amplifier. 200 W/channel, 4 channels driven. Price: \$824.50.

All sales final. Prices FOB factory. Standard 3 year warrantee applies. Cash or certified check payment only. California residents add 6% sales tax to price.

**Contact: Lee, BGW Systems, Inc.  
13130 S. Yukon Ave.,  
Hawthorne, Ca. 90250.  
(213) 973-8090.**



FOR SALE: Tape recorders: Scully 284-8 w/sync master ElectroSound ES505, 2-track. Also, 35 mm. projector w/accessories. All in excellent condition. Priced to sell. Phone (615) 227-5027. Woodland Sound Studios, 1011 Woodland St., Nashville, Tenn. 37206.

REVOX MODIFICATIONS, Variable pitch for A77; In-Sync for A77; In-Sync for A700; Programmer for A77; Thirty inch echo; Rack mounts; Slow speed 1 7/8; Full track. New machines available with or without mods at low cost. All mods professionally performed by Revox trained technicians. Entertainment Sound and Services, Inc., 78 North Franklin Avenue, Hempstead, N.Y. 11550. (516) 538-2220.

AMPEX MM1100 with 16-track heads, sync., search-to-cue, vso; one year old, mint condition. \$16,000. Soundesigns, Inc. (212) 765-7790.

POLYMOOG polyphonic synthesizer. used once; full warranty; mint. \$2,975. (614) 382-3620.

TASCAM MODEL 5, demo with full warranty; like new: \$1,400. Allen & Heath mini-mixer, Model 142 with transformers; 6-in/2-out; \$450. Maxell, MXR, Disc-washer products. N.A.B. Audio, Box 7, Ottawa, Ill. 61350.

REMOTE VAN. 1972 Ford E-100, fully finished interior; 16 inputs/2-4-8 out: full patch bay; RCA BA-6A; Teac 7030; Tascam Model 5; M-67's; MX-10 (solid state); Crown; JBL; Soundcraftsman; 100 ft. snake; stands; Neumann; RCA; Superscope; B&O E-V; AKG; much more. Color photos and detailed information, \$10 (refundable). Rick Shultz, 19 Hillcroft Lane, Cherry Hill, N.J. 08034. (609) 667-0346.

FOR SALE: A.P.I. console w/65k automation; 28/24; four years old and in prime condition. Reason for sale: growth, going 32-track. Available for in-use inspection. Call (802) 763-7714. Ask for Jonathan.

SOUNDESIGNS, Inc., authorized 3M dealership, selling and servicing all 3M professional machines: 24-, 16-, 8-, 4-, and 2-track and Selectake II. Soundesigns, Inc., 313 W. 57th St., Suite 2A, New York, N.Y. 10019. (212) 765-7790.

FOR SALE: DISC CUTTING LATHE. Neumann computer helium head 5 x 68 lathe with Neumann (Telefunken) master playback console. Stereo and mono cutting heads, full eq., EMT PDM (151) loudness limiter. Located in Los Angeles, Ca. Reply to Dept. 101, db Magazine, 1120 Old Country Rd., Plainview, N.Y. 11803.

SCULLY 284-8 8 track with Sync-master. Like new, \$7,000. AMPEX 1/2" HEAD STACKS HI-Z Excel. Cond., 4 Track \$150, 3 Track \$100. 2 AMPEX 354 Electronics \$200 ea. 2 PRESTO 1-D Cutter Heads with Hot Stylus \$150 ea. 2 Fairchild 523 Lathes with Scopes, One 33-45-78 RPM \$350, one 33-78 RPM \$250. AMPEX 4 Channel Sync Switching Panel. AMPEX 401 Complete. PRESTO 900 Complete with Mixer. Delta Recording Co. (212) 840-1350 757-6720.

MXR'S DIGITAL DELAY system. Maxell tape. all widths. discounted. N.A.B. Audio, Box 7B, Ottawa, Ill. 61350.

VOLUME USERS of premium grade 7" open reel tape. Our case lot prices cannot be beat. Maxell UD and UD back-coated, 7" only. Write for case lot quotation. Dept. 102, db Magazine, 1120 Old Country Rd., Plainview, N.Y. 11803.

STUDER 189.080 console, 16 x 8 (patch to 16); excellent eq., 2 pre/post sends, 4 extensive comp/limiters; mint. \$26,000. Soundesigns. (212) 765-7790.

SERVICEMEN — Cleaners, Lubricants. Adhesives for all electronic repairs. Write for free catalog. Projector-Recorder Belt Corp., Box 176, Whitewater, WI 53190. (414) 473-2151.

AUDIO BEEPER, can be used for all audio-visual systems. Call or write C-Tronics, P.O. Box 84, East Brunswick, N.J. 08816. (201) 254-9487.

EVENTIDE DIGITAL DELAY. 2 outputs with pitch controller. Demo used only once. Sold new at \$4,950, sell at \$4,200. Track Audio Inc., (206) 941-2233 call collect.

FOR SALE: TASCAM Model 10 Console, 12X4 with +4 dBm balanced line amps and remote control. Has built in Mic transformers, phone jacks for line inputs. highly modified for 20 dB headroom. Used extensively with many major artists. \$2,700. Omega Audio (214) 226-7179.

AUDIOARTS 3100A parametrics pair. Factory updated 8/77. \$425 unconditionally guaranteed. SOUND SERVICE, 1906 Beacon St., Brookline, Ma. 02146. (617) 734-2727.

CARRIER CURRENT non-profit and non-commercial neighborhood radio station needs broadcast cartridges, new or used; asking for donation. William Blew, 7113 Guyer Ave., Phila., Pa. 19153.

SPECTRA SONICS custom console 16 X 16, 32 pan pots. Currently in use; good quiet board. \$10,000 or best offer. Fifth Floor Recording. (513) 651-1871.

## WANTED

WANTED: USED RECORDING GEAR of all ages and variety; Neumann mics and EMT plates. Dan Alexander, 1345 Grove St., Berkeley, Ca. 94709. (415) 232-7933, (415) 524-9590.

WANTED: Neve or Trident board, etc.: 8-track recorder (Ampex, MCI, etc.); Neumann microphones. Box 2159, Winnipeg, Manitoba, Canada R3C 3R2. (204) 888-6099.

WANTED: RECORDING CONSOLE 16-in/16-out; 16-track recorder; misc. equipment. Send particulars. LeMans Sound, Box 24, Belle Mead, N.J. 08502.

## EMPLOYMENT

ENGINEER. I've sold my successful small studio in New England and would like to work in a studio outside the U.S., in Hawaii, the Southwest or deep south. Some investment capital available in right circumstances. Pitt Kinsolving, 70 Turner Hill Rd., New Canaan, Ct. 06840. (203) 966-0765.

PROJECT MANAGER/ENGINEER to take charge of design, fabrication, and installation of complex professional sound systems for large auditoriums, arenas, buildings, etc. You must have an EE degree or equivalent experience, and a proven record of accomplishments. Position offers significant individual recognition. Age no hindrance. This is a new position in our expanding engineering department and is an excellent opportunity to join the national leader. Salary open. Phone or write, Mr. David Butz in strict confidence. New Jersey Communications Corporation, Kenilworth, N.J. 07033. (201) 245-8000.

MUZAK FRANCHISE needs sound serviceman and salesman-operations manager. Joe Warner, President, Muzak, P.O. Box 4005, Rocky Mount, N.C. 27801.

FIELD INSTALLERS, SHOP FABRICATORS, FIELD SERVICE FOR CUSTOM SOUND SYSTEMS. Large ALTEC sound contractor expanding organization because business has been good for us. Must be experienced. Permanent jobs, top salary for good workers. Phone: (201) 245-8000, Fred, New Jersey Communications Corp., 144 Market Street, Kenilworth, N.J. 07033.

EXPERIENCED MUSIC MIXER  
Major N.Y.C. studio. New automated 24-track. Send resume to Dept. 83, db Magazine, 1120 Old Country Rd., Plainview, N.Y. 11803.

# db People/Places/Happenings

● **Aubrey L. Stewart** has been named national sales manager for amateur radio products at **Swan Electronics** in Oceanside, Ca. He replaces **Leo McCullough**, who was promoted to the post of assistant marketing manager.

● **Precision Cable Mfg. Co., Inc.**, producers of audio patch cords, has opened a new manufacturing division in Garland, Texas. The location of the facility is at 2722 National.

● Responsibility for coordinating marketing, engineering and manufacturing during the development and start-up operations of new products at **Altec Lansing Corporation** of Anaheim Ca. will be focalized by **Don Hudson**, recently appointed to the newly created position of director of operational planning. Mr. Hudson has been with Altec Lansing for the past three years.

● **Leonard B. Lapine** has been appointed to national sales manager for the Imperial division of **Superscope**, Chatsworth, Ca. The new Imperial line includes stereo music systems, consoles, consolettes, electronic digital clock radios, portable radios, and cassette tape recorders.

● Three newly-created managerial appointments have been filled at **Warner Cable Corporation's QUBE** division in New York City. **James U. Daley**, will be director of finance. **Gene Haist** has been selected to head personnel functions. **James L. Williamson** will be in charge of customer relations. QUBE is an experimental program in progress in Columbus, Ohio which provides home t.v. viewers with a special terminal which permits responsive participation on the part of the viewer in games, quizzes, discussions, etc.

● The post of religious broadcasting sales specialist at **CCA Electronics Corporation**, Cherry Hill, N.J. has been filled by **Bill Kitchen**. Mr. Kitchen, who was previously executive vice president of **CLW, Inc.**, will maintain a liaison in sales and engineering with religious broadcasters. Another recent appointment is that of **Carolyn Alk** as marketing services manager. The company has recently sold its subsidiaries, **QRK Electronic Products, Inc.** and **Rek-O-Cut, Inc.**, located in Fresno, Ca. to **Robert D. Sidwell**, CCA vice-president for southern domestic sales.

● The **Treehouse**, originated by the **Van Christo Radio Theater** of Boston, Mass. was one of three children's program's cited for excellence by the **Corporation for Public Broadcasting**. Cast members include **Herbert Wolff**, **Tana Christo**, **Philip Cronin**, **Tobyn Winslow**, **Pira Christo**, **Lee Trocki**, **Tony Cennamo**, and **Ben Bolt**.

● Three regional sales managers have been appointed by **Mitsubishi Audio**. **Dan Fujii** will be in charge of the west and southwest regions. The mid-west and southeast will be represented by **Gary Hartfelder**. **Kevin McDermott** will be responsible for sales efforts in the mideast and New England.

● **Pat Appleson**, president of **Appleson Studios** of N. Miami Beach, Florida has been elected chairman of the South Florida chapter of the **Audio Engineering Society**. Mr. Appleson hopes to center the Fall A.E.S. convention in Miami Beach in the near future.

● **Audio-Technica U.S. Inc.**, of Fairlawn, Ohio will begin distributing **Sonic Arts** direct-to-disc recordings shortly. This is their second label, following the **Umbrella** recordings which the firm imports from Toronto. Direct-disc records are recorded directly onto a master disc without intermediate tape mixing.

● **Vlasonik of America, Inc.** of Oakland, Ca. announces the appointment of **Lawrence H. Lurie** as national sales manager for the firm's turntable line. Mr. Lurie's background is strong in the sales promotion area with an advertising and electronic base. He was most recently vice president of **G. R. Squires & Company**.

● **Armond Gease** has joined the sales staff of **Kodo Associates**, of Minneapolis, Minn. Mr. Gease comes to Kodo from **Stark Electronic Supply Company**, a firm with which he was associated for 25 years.

● **Hammond Industries** of Syosset, N.Y. has been appointed exclusive U.S. distributors for **Ferrograph** test equipment. Included among the items available is the **RTS 2** test set, including a signal generator, millivoltmeter, distortion analyzer, wow and flutter meter operating through one input facility.

● Appointment of **Stanley E. Basara** as manager, studio and control equipment engineering and product management for **RCA Broadcast Systems** of Moorestown, N.J. has been announced. Mr. Basara is responsible for product management of the firm's television cameras, t.v. film systems and associated control equipment. Mr. Basara was previously with RCA's West Palm Beach, Florida operation.

● **Praise Recordings, Inc.** of Baltimore, Md. has acquired **Bradley Recording Company**, according to **Carroll R. Johnson, Jr.** president of Praise Recording. The combined firm is housed in a new location, 531 N. Howard St., where a 16-track capacity will permit professional recording. In addition to in-house recording, they handle audio for radio and t.v. commercials, convention taping, and high speed cassette duplication as well as location recording.

● **Brad Varnum**, coming from **Litton Resources, Inc.** has joined **Dataflux Corporation** as vice president of engineering. Mr. Varnum will be responsible for all engineering work on Dataflux's line of fixed head discs and controllers as well as new product development. Dataflux has recently moved to larger quarters at 1050 Stewart Drive, Sunnyvale, Ca.

● **Rep-Tron, Inc.** of Columbia, Maryland has been appointed as representative for **General Semiconductor Industries** for the states of Maryland, Virginia, Delaware, and the District of Columbia. Rep-Tron was founded in 1968.

● Electronic cable manufacturer, **Belden Corporation**, has opened a regional sales office, serving eight western states, in Irvine, Ca. The facility is located in Douglas Plaza at 2222 Martin St.

● Two new sales positions have been filled at **James B. Lansing Sound** of Northridge, Ca., by **Tom Frisina** and **Bill Robinson**. Mr. Frisina has been named national sales manager for high fidelity products and Mr. Robinson will serve as marketing manager for high fidelity products. Both men have been with the firm for a number of years.

# John Woram's The Recording Studio Handbook

FOR RECORDING ENGINEERS,  
TECHNICIANS AND AUDIOPHILES

The technique of creative sound recording has never been more complex than it is today. The proliferation of new devices and techniques require the recording engineer to operate on a level of creativity somewhere between a technical superman and a virtuoso knob-twirler. This is a difficult and challenging road. But John Woram's new book will chart the way.

*The Recording Studio Handbook* is an indispensable guide. It is the audio industry's first complete handbook that deals with every important aspect of recording technology.

Here are the eighteen chapters:

- The Decibel
- Sound
- Microphone Design
- Microphone Technique
- Loudspeakers
- Echo and Reverberation
- Equalizers
- Compressors, Limiters and Expanders
- Flanging and Phasing
- Tape and Tape Recorder Fundamentals
- Magnetic Recording Tape
- The Tape Recorder
- Tape Recorder Alignment
- Noise and Noise Reduction Principles
- Studio Noise Reduction Systems
- The Modern Recording Studio Console
- The Recording Session
- The Mixdown Session

In addition, there is a 36-page glossary, a bibliography and five other valuable appendices.

John Woram is the former Eastern vice president of the Audio Engineering Society, and was a recording engineer at RCA and Chief Engineer at Vanguard Recording Society. He is now president of Woram Audio Associates.

This hard cover text has been selected by several universities for their audio training programs. With 496 pages and hundreds of illustrations, photographs and drawings, it is an absolutely indispensable tool for anyone interested in the current state of the recording art.

Use the coupon at the right to order your copy of *The Recording Studio Handbook*. The price is only \$35.00, sent to you with a 15-day money-back guarantee.

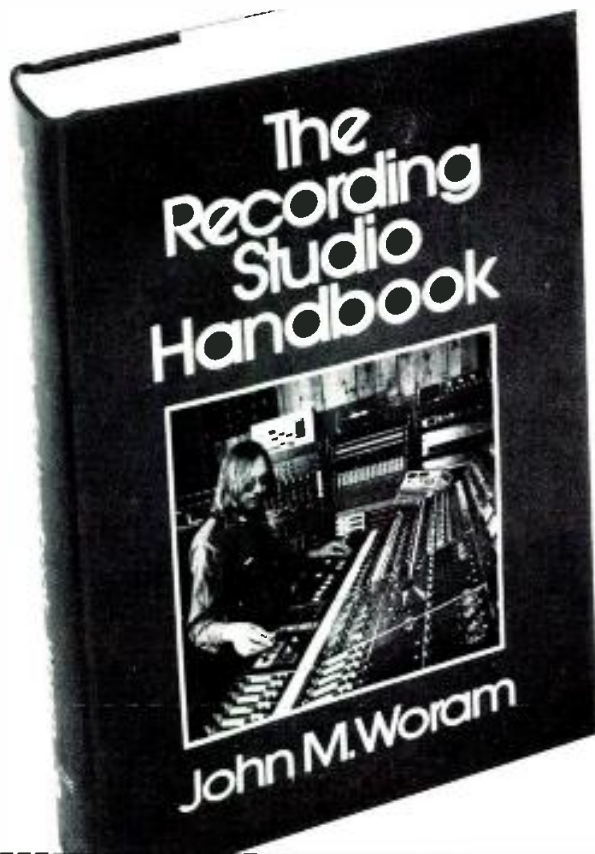

SAGAMORE PUBLISHING COMPANY, INC.  
1120 Old Country Road, Plainview, N.Y. 11803

Yes! Please send \_\_\_ copies of *The Recording Studio Handbook* at \$35.00 each. On 15-day approval.

Name \_\_\_\_\_

Address \_\_\_\_\_

City/State/Zip \_\_\_\_\_

Total Amount \_\_\_\_\_

N.Y.S. Residents add appropriate sales tax \_\_\_\_\_

Enclosed in payment for \$ \_\_\_\_\_  
Outside U.S.A. add \$2.00 for postage

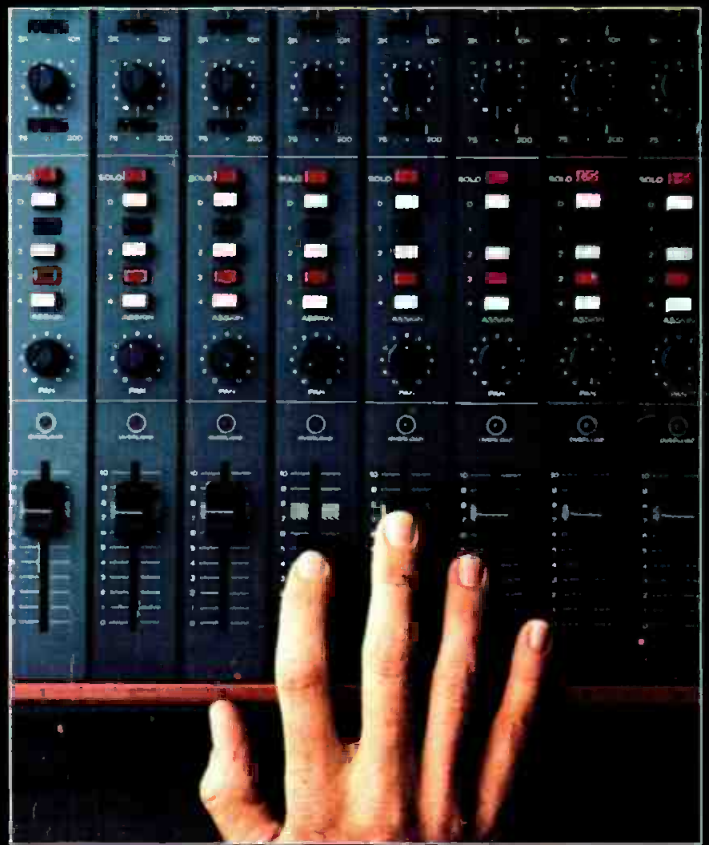
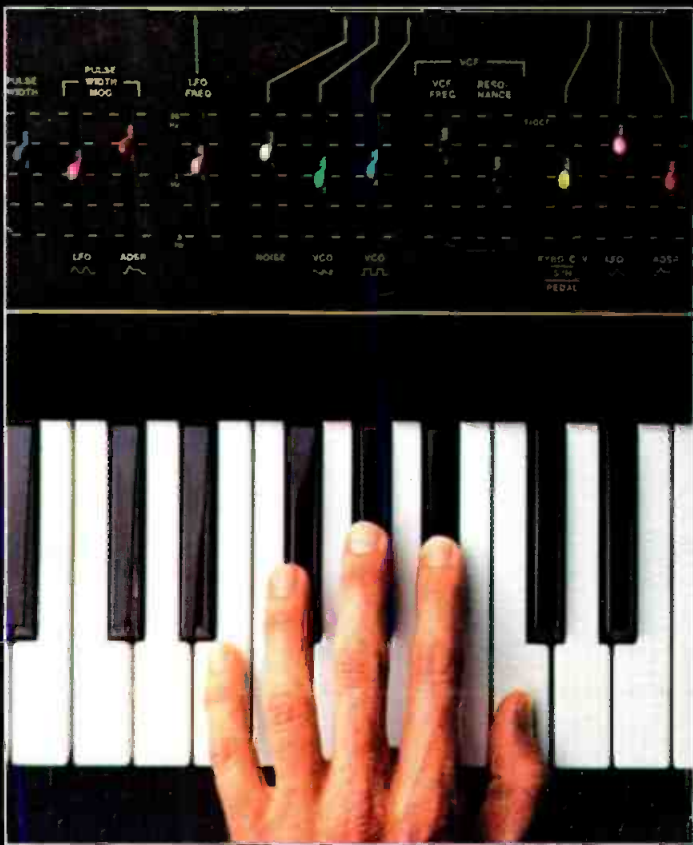

# THIS IS WHERE TOMORROW'S GREAT MUSIC IS COMING FROM.

We think musical styles change because musical talents change.

There is hardly a musician making money today who doesn't know as much about recording music as he does about playing it. And recordists know as much about playing music as they do about recording it.

Because both know the equipment that captures music can also be used to improve it.

So while musical styles may change, the interdependence of musician, recordist, and the instruments they use will not. And that is the reason for the TASCAM Series by TEAC.

For not very much money TASCAM lets both musician and recordist get their hands on mixers and recorder/reproducers that let both tailor their music their way.

The Model 5-EX shown with four Model 201 input modules. Model 5 shown with Model 204 talk back/slate modules.

For every kind of music, for every kind of need, at home and on the road, by price and application, everything we make

has the same goal as everything you make—be the best.

Because it still takes great talent to make great music.

## TASCAM SERIES BY TEAC®

A new generation of recording instruments for a new generation of recording artists.

TEAC Corporation of America  
7733 Telegraph Road  
Montebello, California 90640

In Canada TEAC is distributed by White Electronic Development Corporation (1966) Ltd.

